

VesseLINK™ Installation Guide

This document contains technology controlled for export by the U.S. Department of Commerce in accordance with Export Administration Regulations. Diversion contrary to U.S. law prohibited.



RECORD OF CHANGES

| Rev | Date | Description of Change | Author |
|------------|-------------|--|---------------|
| Rev A | July 2018 | Initial Release | SJacques |
| Rev B | Sept 2018 | ECN 42140 <ul style="list-style-type: none"> Update based on Beta user feedback and testing | SJacques |
| | | | |
| | | | |
| | | | |
| | | | |
| | | | |
| | | | |
| | | | |
| | | | |
| | | | |
| | | | |
| | | | |
| | | | |
| | | | |
| | | | |
| | | | |
| | | | |
| | | | |
| | | | |
| | | | |
| | | | |
| | | | |

WARNING – INFORMATION SUBJECT TO EXPORT CONTROL RESTRICTIONS

This document contains technology controlled for export by the U.S. Department of Commerce in accordance with Export Administration Regulations (EAR). Diversion contrary to U.S. law prohibited. Include this notice with any reproduced portion of this document.

Export Compliance:

This product is controlled by the export laws and regulations of the United States of America. The U.S. Government may restrict the export or re-export of this product to certain individuals and/or destinations. For further information, contact the U.S. Department of Commerce, Bureau of Industry and Security.

This product User shall comply with all applicable laws related to export and import of this product in any jurisdiction and/or government authority. User shall be responsible for complying with any and all export and import restrictions, laws and regulations in any country User is conducting business.

Disclaimer:

This manual contains information that is current as of the date shown on the front cover. Every effort has been made to ensure the correctness and completeness of the material in this document. The information in this document is subject to change without notice. Thales®, Thales VesseLINK™, and any other Thales trademark or Thales service mark referred to or displayed in this document are trademarks or registered trademarks of Thales.

Legal Notices

This product is subject to a Limited Warranty, Limitations, Exclusions, and Terms and Conditions, which can be found on line at www.thalesdsi.com.

Prior to Installing this product, read and understand this Installation Guide and the User Manual, including the safety warnings and information. Failure to do so could result in serious injury or death.

Intellectual Property

User acknowledges that the Products involve valuable patent, copyright, trademark, trade secret and other proprietary rights of Thales and others. No title to or ownership of any proprietary rights related to any Product is transferred to User or any Customer pursuant to the use of this product. The purchase of any Thales products shall not be deemed to grant either directly or by implication or otherwise, any license under copyrights, patents, or patent applications of Thales or any third party software providers, except for the normal, nonexclusive, royalty free license to use that arises by operation of law in the sale of a product.

Content Copyright

User is exclusively responsible for the use of this product, including proper use of third party copyrighted materials. If the User violates these terms, the User agrees to defend, indemnify and hold Thales harmless with respect to any claims or actions by third parties related to the improper use of copyrighted material and to pay all costs, damages, fines and other amounts incurred by Thales, or on its behalf, in the defense of any such claims or actions.

Indemnity

User agrees to defend, indemnify and hold Thales harmless with respect to any claims or actions by any governmental entities or other third parties related to any violation of law with use of the Product or Accessories, misuse of the Product or Accessories under these Terms and Conditions, or any other violation of these Terms and Conditions and further agrees to pay all costs, damages, fines and other amounts incurred by Thales, or on Thales's behalf, in the defense of any such claims or actions.

SOFTWARE LICENSE

The following terms govern User's access and use of the Thales-supplied software ("Software") contained on the Product or Accessories.

License. Conditioned upon compliance with these Terms and Conditions, Thales grants to USER a nonexclusive and nontransferable license to use for USER's internal purposes the Software and the Documentation. "Documentation" means any written information pertaining to the Software and made available by Thales with the Software in any manner. USER shall use the Software solely as embedded for operation of this product.

No other licenses are granted by implication, estoppel or otherwise.

Thales Product Warranty Claim Process

Please see the Thales website at www.thalesdsi.com.

User Documentation:

THALES DEFENSE & SECURITY, INC. CONTINUALLY EVALUATES ITS USER DOCUMENTATION FOR ACCURACY AND COMPLETENESS. ANY SUGGESTIONS YOU MAY HAVE FOR CHANGES OR ADDITIONS SHOULD BE SENT TO THALES_ILS@THALESDSI.COM SUBJECT LINE: THALES VESSELINK™ INSTALLATION GUIDE (PN 84464).

TABLE OF CONTENTS

| | |
|---|------------|
| RECORD OF CHANGES | ii |
| SAFETY | vi |
| FCC INFORMATION..... | VIII |
| CHAPTER 1 INTRODUCTION | 1-1 |
| INTRODUCTION | 1-1 |
| EQUIPMENT OVERVIEW | 1-1 |
| Below Deck Unit (BDU) | 1-2 |
| Above Deck Unit (ADU) / Antenna | 1-5 |
| VESSELINK™ KIT COMPONENTS..... | 1-6 |
| TOOLS AND SUPPLIES NEEDED FOR INSTALLATION..... | 1-7 |
| CHAPTER 2 INSTALLATION | 2-1 |
| GENERAL GUIDELINES | 2-1 |
| Preparation | 2-1 |
| Precautions During Installation..... | 2-1 |
| INSTALLATION | 2-2 |
| MOUNTING THE ABOVE DECK UNIT (ANTENNA) | 2-2 |
| Installation of ADU / Antenna..... | 2-5 |
| INSTALLING THE BELOW DECK UNIT | 2-10 |
| CONNECTING POWER TO THE BDU..... | 2-13 |
| DC Power Connection | 2-14 |
| SYSTEM STATUS INDICATORS | 2-16 |
| CHAPTER 3 TROUBLESHOOTING | 3-1 |
| TROUBLESHOOTING..... | 3-1 |
| CHAPTER 4 TECHNICAL SPECIFICATIONS | 4-1 |
| TECHNICAL SPECIFICATIONS..... | 4-1 |
| CONNECTOR DETAILS:..... | 4-3 |
| General Purpose Inputs / Outputs (GPIO) | 4-3 |
| BDU 12V Connection Detail..... | 4-4 |
| BDU 10-32VDC Connection Detail..... | 4-4 |
| CHAPTER 5 ACRONYMS / GLOSSARY | 5-1 |
| ACRONYMS / GLOSSARY | 5-1 |
| INDEX | INDEX-1 |
| APPENDIX A ANTENNA MOUNTING PLATE TEMPLATE (PN 3900014-1) | A-1 |
| APPENDIX B BDU MOUNTING PLATE TEMPLATE (PN 3900011-1)..... | B-1 |
| APPENDIX C ANTENNA POLE MOUNTING (OPTIONAL)..... | C-1 |

LIST OF FIGURES

| | |
|--|------|
| FIGURE 1-1 THALES VESSELINK™ SYSTEM WITH ACCESSORIES | 1-1 |
| FIGURE 1-2 BELOW DECK UNIT (BDU) | 1-2 |
| FIGURE 1-3 BELOW DECK UNIT (BDU) LEDs..... | 1-3 |
| FIGURE 1-4 BELOW DECK UNIT (BDU) FRONT PANEL DETAIL | 1-4 |
| FIGURE 1-5 BELOW DECK UNIT (BDU) BACK PANEL DETAIL..... | 1-4 |
| FIGURE 1-6 ABOVE DECK UNIT (ADU) / ANTENNA | 1-5 |
| FIGURE 2-1 PLACING ANTENNA FOR OPTIMUM PERFORMANCE | 2-3 |
| FIGURE 2-2 RECOMMENDED ANTENNA PLACEMENT WITH EXISTING RADAR | 2-4 |
| FIGURE 2-3 MOUNTING HOLES IN BOTTOM OF ANTENNA AND MTG TEMPLATE (INCL IN KIT) | 2-5 |
| FIGURE 2-4 ABOVE DECK UNIT / ANTENNA INSTALLATION (M6 HARDWARE)..... | 2-7 |
| FIGURE 2-5 ABOVE DECK UNIT / ANTENNA INSTALLATION (M10 HARDWARE)..... | 2-9 |
| FIGURE 2-6 BELOW DECK UNIT (BDU) MOUNTING DETAIL | 2-10 |
| FIGURE 2-7 SIM CARD WITH COVER OPENED | 2-11 |
| FIGURE 2-8 INSTALLING SIM CARD AND ENGAGING THE LOCK | 2-12 |
| FIGURE 2-9 SECURE THE SIM CARD COVER | 2-12 |
| FIGURE 2-10 AC/DC POWER SUPPLY | 2-13 |
| FIGURE 2-11 24V DC POWER CONNECTION | 2-14 |
| FIGURE 2-12 24V DC POWER CONNECTION | 2-15 |
| FIGURE 2-13 BELOW DECK UNIT (BDU) LEDs..... | 2-16 |
| FIGURE 4-1 GPIO CONNECTOR PIN DETAIL | 4-3 |
| FIGURE 4-2 12V INPUT AND MATING CONNECTOR DETAIL | 4-4 |
| FIGURE 4-3 10-32 VDC AND MATING CONNECTOR DETAIL..... | 4-4 |
| FIGURE C-1 THALES ANTENNA MOUNTING BRACKET (SHOWN WITH POLES, NOT INCLUDED) .. | C-1 |
| FIGURE C-2 THALES ANTENNA POLE MOUNT KIT – M6 (PN 85736-001)..... | C-2 |
| FIGURE C-3 THALES ANTENNA POLE MOUNT KIT – M10 (PN 85739-001)..... | C-3 |

LIST OF TABLES

| | |
|---|------|
| TABLE 1-1 BELOW DECK UNIT (BDU) LED STATUS | 1-3 |
| TABLE 1-2 STANDARD VESSELINK™ KIT, LIST OF EQUIPMENT | 1-6 |
| TABLE 1-3 AVAILABLE VESSELINK™ ACCESSORIES | 1-7 |
| TABLE 2-1 INSTALLATION KIT, MOUNTING HARDWARE (M6 HARDWARE)..... | 2-7 |
| TABLE 2-2 INSTALLATION KIT, MOUNTING HARDWARE (M10 HARDWARE)..... | 2-9 |
| TABLE 2-3 INSTALLATION KIT, BELOW DECK UNIT (BDU) (PN 1100789-501)..... | 2-10 |
| TABLE 2-4 BELOW DECK UNIT (BDU) LED STATUS | 2-16 |
| TABLE 3-1 TROUBLESHOOTING..... | 3-1 |
| TABLE 4-1 TECHNICAL SPECIFICATIONS | 4-1 |
| TABLE 4-2 GPIO CONNECTOR PIN DEFINITION | 4-3 |
| TABLE 5-1 LIST OF ACRONYMS..... | 5-1 |
| TABLE 5-2 LIST OF DEFINITIONS..... | 5-2 |

SAFETY

The VesseLINK™ system should only be installed by a qualified professional installer of Maritime electronic systems. Improper installation could lead to system failure or could result in injury to personnel on board the vessel. The following are general safety precautions and warnings that all personnel must read and understand prior to installation, operation and maintenance of the VesseLINK™ system. Each chapter may have other specific warnings and cautions.



WARNING

SHOCK HAZARD

The VesseLINK™ system is a sealed system and is not meant to be opened for repair in the field by operators or technicians. Covers must remain in place at all times on the BDU and ADU to maintain the warranty terms. Make sure the system is correctly grounded and power is off when installing, configuring and connecting components.



WARNING

DO NOT OPERATE IN AN EXPLOSIVE ATMOSPHERE

This equipment is not designed to be operated in explosive environments or in the presence of combustible fumes. Operating this or any electrical equipment in such an environment represents an extreme safety hazard.



CAUTION

LITHIUM ION BATTERIES

The Below Deck Unit (BDU) contains a small Li-ion hold-up battery. Li-ion batteries have a very high energy density. Exercise precaution when handling and testing. Do not short circuit, overcharge, crush, mutilate, nail penetrate, apply reverse polarity, expose to high temperature or disassemble. High case temperature resulting from abuse of the cell could cause physical injury.



ANTENNA RADIATION HAZARDS

To comply with FCC Radio Frequency radiation exposure limits, the antenna must be installed at a minimum safe distance as shown below.

During operation, the antenna radiates high power at microwave frequencies that can be harmful to individuals. While the unit is operating, personnel should maintain a minimum safe distance of **1.5 meters (4.9 ft.)** from the antenna. The antenna should be mounted in an area that prevent the possibility of close exposure to the antenna's radiation.

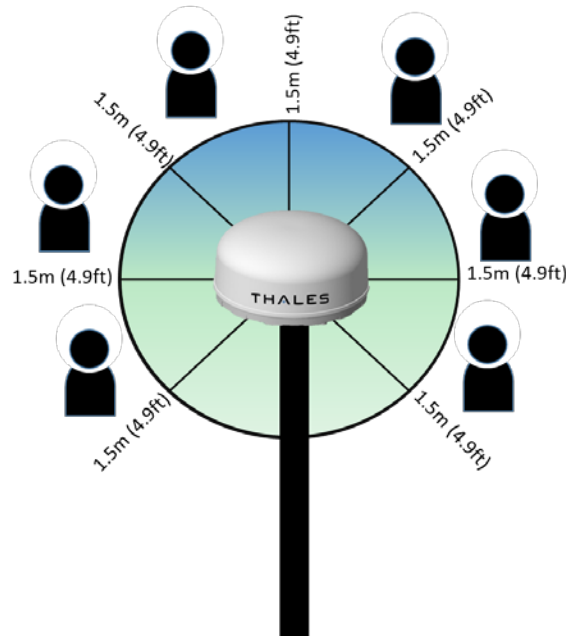

FCC Information



NOTE

FCC Identifier: OKCVF350BM

Contains FCC ID: QQQWF121

Changes or modifications not expressly approved by the manufacturer could void the user's authority to operate the equipment.

Note:

This equipment has been tested and found to comply with the limits for a [Class B digital device](#), pursuant to part 15 of the FCC Rules. These limits are designed to provide reasonable protection against [harmful interference](#) in a residential installation. This equipment generates, uses and can radiate [radio frequency energy](#) and, if not installed and used in accordance with the instructions, may cause [harmful interference](#) to radio communications. However, there is no guarantee that interference will not occur in a particular installation. If this equipment does cause [harmful interference](#) to radio or television reception, which can be determined by turning the equipment off and on, the user is encouraged to try to correct the interference by one or more of the following measures:

- Reorient or relocate the receiving antenna.
- Increase the separation between the equipment and receiver.
- Connect the equipment into an outlet on a circuit different from that to which the receiver is connected.
- Consult the dealer or an experienced radio/TV technician for help.

Industry Canada Information



NOTE

Industry Canada: 473C-VF350BM
Contains IC: 5123A-BGTWF121

Under Industry Canada regulations, this radio transmitter may only operate using an antenna of a type and maximum (or lesser) gain approved for the transmitter by Industry Canada. To reduce potential radio interference to other users, the antenna type and its gain should be so chosen that the equivalent isotropically radiated power (e.i.r.p.) is not more than that necessary for successful communication.

Conformément à la réglementation d'Industrie Canada, le présent émetteur radio peut fonctionner avec une antenne d'un type et d'un gain maximal (ou inférieur) approuvé pour l'émetteur par Industrie Canada. Dans le but de réduire les risques de brouillage radioélectrique à l'intention des autres utilisateurs, il faut choisir le type d'antenne et son gain de sorte que la puissance isotrope rayonnée équivalente (p.i.r.e.) ne dépasse pas l'intensité nécessaire à l'établissement d'une communication satisfaisante.

This radio transmitter (473C-VF350BM) has been approved by Industry Canada to operate with the antenna listed in Table 4-1 with the maximum permissible gain and required antenna impedance for each antenna type indicated. Antenna types not included in this list, having a gain greater than the maximum gain indicated for that type, are strictly prohibited for use with this device.

Le présent émetteur radio (473C-VF350BM) a été approuvé par Industrie Canada pour fonctionner avec les types d'antenne énumérés ci-dessous et ayant un gain admissible maximal et l'impédance requise pour chaque type d'antenne. Les types d'antenne non inclus dans cette liste, ou dont le gain est supérieur au gain maximal indiqué, sont strictement interdits pour l'exploitation de l'émetteur.

This device complies with Industry Canada license-exempt RSS standard(s). Operation is subject to the following two conditions: (1) this device may not cause interference, and (2) this device must accept any interference, including interference that may cause undesired operation of the device.

Le présent appareil est conforme aux CNR d'Industrie Canada applicables aux appareils radio exempts de licence. L'exploitation est autorisée aux deux conditions suivantes: (1) l'appareil ne doit pas produire de brouillage, et (2) l'utilisateur de l'appareil doit accepter tout brouillage radioélectrique subi, même si le brouillage est susceptible d'en compromettre le fonctionnement.

Thales Defense & Security, Inc.

Declaration of Conformity with Radio Equipment Directive

The undersigned of this letter declares that the following equipment complies with the specifications of Radio Equipment Directive (2014/53/EU) concerning Radio & Telecommunications Equipment.

Equipment included in this declaration

VF350BM VesseLINK Broadband Maritime Certus Satellite Terminal and Antenna

MF350BV MissionLINK Broadband Maritime Certus Satellite Terminal and Antenna

Equipment Applicability

The VesseLINK and MissionLINK provide voice and high speed data communication over 100% of the globe through the Iridium Certus broadband Satellite system.

Declaration

The health requirement is met by conforming to EU standard EN 62311. The safety requirement is met by conforming to EN 60950-1:2006 w/A2:2013. The electromagnetic compatibility as set out in Directive 2014/30/EU is met by conforming to the EU standards ETSI EN 301-489-1 and ETSI EN 301-489-17. Effective and efficient use of radio spectrum in order to avoid harmful interference is met by conforming to the ETSI EN 301-441 standard.

Manufacturer

Thales Defense & Security, Inc. 22605 Gateway Center Drive
Clarksburg, Maryland 20871 U.S.A.

Place and Date

Clarksburg, MD, 15 August 2018

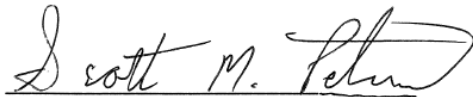

Scott Peters

Director, Product Management

CHAPTER 1 INTRODUCTION

Introduction

This installation guide provides instructions for proper installation and initial start-up of the VesseLINK™ system and a basic system overview. It contains critical information and safety guidelines for those who install the system and perform initial system activation and test.

After initial start-up, for more detailed operational procedures, refer to the VesseLINK™ User Manual (Document # 84469) located on the Thales website and is also accessible through the terminal's Management Portal.

Equipment Overview

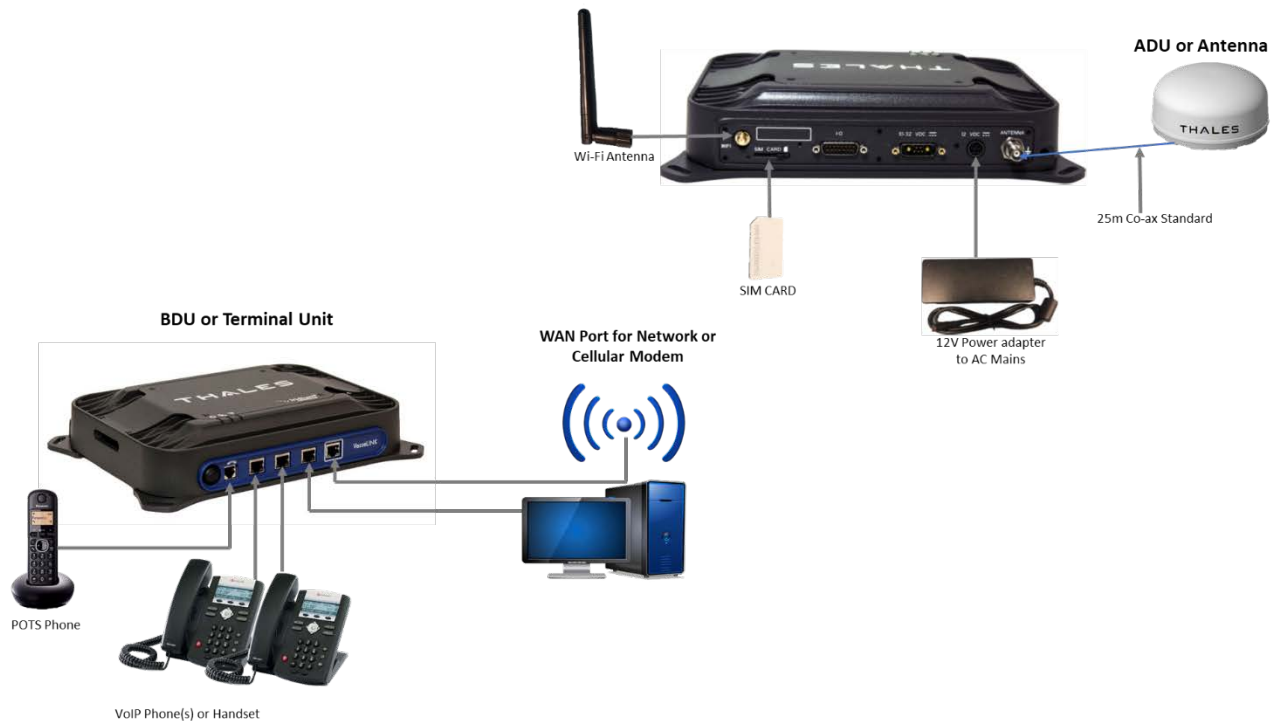

Figure 1-1 Thales VesseLINK™ System with Accessories

Below Deck Unit (BDU)

The Below Deck Unit (BDU) supports voice and data communications in a marine environment. The BDU is capable of supporting wireless voice and data that links the user with the Iridium satellite network. As a wireless access point, the BDU provides Wi-Fi (802.11) access for data and Voice over IP (VoIP) calls. Three RJ-45 Ethernet connectors and one RJ14 jack enables the user to tether directly to the BDU, if desired. The Management Portal is a graphical user interface that can be used to modify system settings and indicate system status. The BDU is powered by an included 12 Volt AC to DC power supply. It also can be powered by an optional DC power cable with a 10-32V input range battery operation where AC power or a DC power inverter is not available.



Figure 1-2 Below Deck Unit (BDU)



NOTE

Wi-Fi Access Point:

The internal Wi-Fi access point is not a high capacity Wi-Fi system. If heavy simultaneous data usage is expected through Wi-Fi, it may be best to use an external commercial Wi-Fi router connected to the BDU's LAN port.

The BDU has three status LEDs on the top of the unit that indicate status of system power-up, satellite connection and the Wi-Fi.

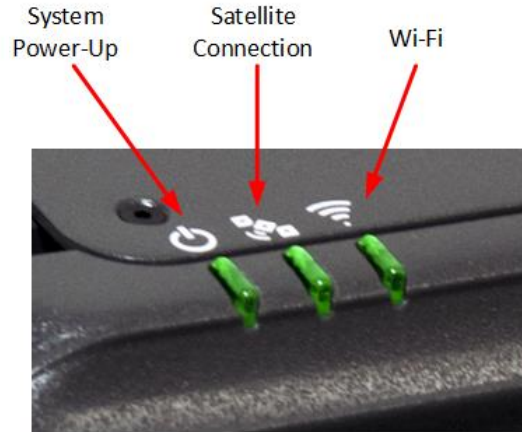





Figure 1-3 Below Deck Unit (BDU) LEDs

Table 1-1 Below Deck Unit (BDU) LED Status

| Indicator | Description |
|--|---|
|  System | |
| Solid GREEN | System functioning properly |
| Flashing GREEN | System busy (Booting up) |
| Solid RED | Fault (minor issue) |
| Flashing RED | Critical fault (major issue) |
|  Satellite | |
| Solid BLUE | Connected and passing data (over satellite) |
| Solid GREEN | System functioning properly |
| Flashing GREEN | Acquiring satellite |
| Solid RED | Fault (minor issue) |
| Flashing RED | Critical fault (major issue) |
|  Wi-Fi | |
| OFF | Wi-Fi OFF |
| Flashing GREEN | Wi-Fi busy |
| Solid Green | System functioning properly |
| Solid RED | Fault (minor issue) |
| Flashing RED | Critical fault (major issue) |



NOTE

The Indicator Colors are:

Solid Green: Operational

Flashing Green: start-up or in progress of configuring or acquiring service.

Solid Red: fault requires user attention (Open Management Portal for Alerts)

Flashing Red: critical fault requiring immediate attention. For additional information, refer to Chapter 3 Troubleshooting

The BDU front panel (left to right) has a main power button, one RJ-14 jack for POTS (Plain Old Telephone Service) Phone(s), three PoE (Power over Ethernet) RJ-45 connections for VoIP phones or Ethernet-based devices, and one WAN (Wide Area Network) connection primarily used to connect an external cellular modem or VSAT.

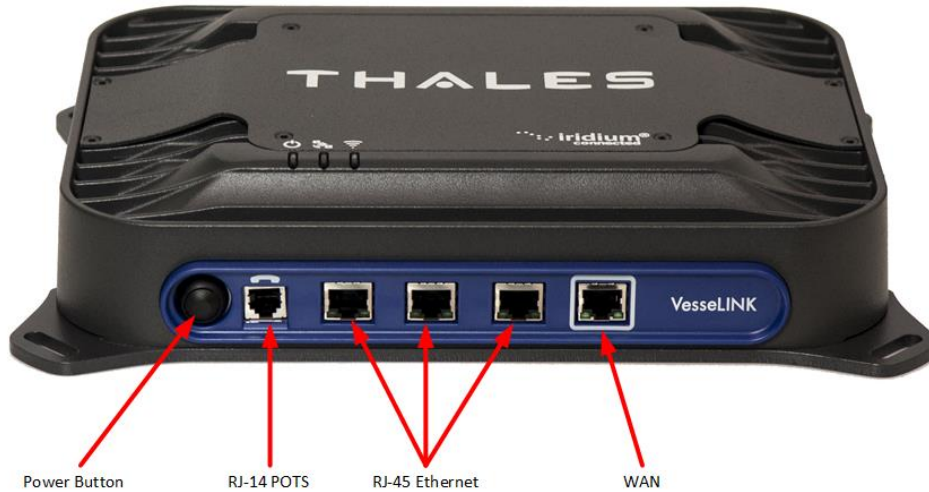

Figure 1-4 Below Deck Unit (BDU) Front Panel Detail

The BDU back panel (left to right) has a Wi-Fi antenna connector, reset button, SIM Card slot, GPIO (I/O) connector, 10-32Volt DC input connector, 12Volt DC power input, antenna connector, and chassis grounding lug.



Figure 1-5 Below Deck Unit (BDU) Back Panel Detail

Above Deck Unit (ADU) / Antenna

The Above Deck Unit (ADU) or Antenna is a standalone unit that connects to the BDU through a single coaxial cable. DC power, RF transmit and receive signals, control data and GPS data are communicated between the ADU and BDU using this single coaxial cable.



Figure 1-6 Above Deck Unit (ADU) / Antenna

VesseLINK™ Kit Components

The following list of equipment can be purchased as a kit and accessories and spares can be purchased separately, depending on your requirements and/or needs.

Table 1-2 Standard VesseLINK™ Kit, List of Equipment

| Part Number | | Description |
|-------------|-------------|---|
| VF350BM | | Kit, VesseLINK™ Kit Vehicular High Gain 350** |
| Qty | Part Number | Description |
| ✓ 1 | 1100789-501 | Kit, Below Deck Unit (BDU), Mounting Hardware |
| ✓ 1 | 1100791-501 | Kit, Antenna Maritime Mounting Hardware |
| ✓ 1 | 1600901-1 | Above Deck Unit / Antenna Unit |
| ✓ 1 | 3402131-1 | Quick Start Guide (QSG) VesseLINK™ |
| ✓ 1 | 3900011-1 | Mounting Template, Terminal Unit |
| ✓ 1 | 3900014-1 | Mounting Template, Antenna |
| ✓ 1 | 4102947-501 | Terminal Unit VesseLINK™ 350 |
| ✓ 1 | 84670-001 | Power Supply, AC/DC 12V – 160W |
| ✓ 1 | 854024-001 | Cable AC Power with USA Plug 6 ft |
| ✓ 1 | 854025-001 | Cable AC Power EURO Plug 6 ft |
| ✓ 1 | 855023-082 | Cable, Coaxial 82 ft LMR300 |
| ✓ 1 | 855026-010 | Cable, RJ-45 Ethernet, 10 ft |
| ✓ 1 | 85728-001 | Wi-Fi Antenna, 2.4 GHz Dipole 2 dBi |

** The VF350BM is capable of up to 350 kbps uplink and downlink speeds.

Note: The SIM card is provided by the airtime service provider and may be packaged separately from this kit.

Table 1-3 Available VesseLINK™ Accessories

| Description | Part Number | Qty |
|--|--------------------|------------|
| 19" Rack Mount Shelf Kit | 1100796-501 | 1 |
| Thales SureLINK IP Handset Kit | 1100818-501 | 1 |
| Power Supply, AC/DC 12V – 160W | 84670-001 | 1 |
| Cable AC Power with USA Plug Type B IEC 60320-C13 6 ft | 854024-001 | 1 |
| Cable AC Power with Euro Plug Type E IEC 320-C14 6 ft | 854025-001 | 1 |
| Cable AC Power with AUS Plug Type 1 IEC 320-C14 6 ft | 854026-001 | 1 |
| Cable AC Power with UK Plug Type G IEC 320-C13 6 ft | 854027-001 | 1 |
| BDU to ADU RF Coaxial Cable, (25m / 82 ft) | 855023-082 | 1 |
| Cable, Vehicle DC Power Harness 20 ft | 855024-020 | 1 |
| Cable, RJ-45 Ethernet, 10 ft | 855026-010 | 1 |
| BDU to ADU RF Coaxial Cable (50m / 164 ft) | 855033-164 | 1 |
| Wi-Fi Antenna, 2.4 GHz Dipole 2 dBi | 85728-001 | 1 |
| Antenna Mounting Plate, Small | 85736-001 | 1 |
| Antenna Mounting Plate, Large | 85739-001 | 1 |

Tools and Supplies Needed for Installation

List of tools you may need to install this system:

- Drill and drill bits
- Pliers or wrench
- 4 mm Hex Drive
- 6 mm Hex Driver
- 10 mm Wrench or Socket
- Torque Wrench
- Marker or pencil
- Tie wraps
- Self-vulcanizing tape to seal connections

THIS PAGE INTENTIONALLY LEFT BLANK

CHAPTER 2 INSTALLATION

GENERAL GUIDELINES

General Guidelines for Installation

- It is recommended to turn on the Below Deck Unit (BDU) only after the antenna and all system cables have been installed and connected.
- Do not attempt to service items such as Below Deck Unit (BDU) and Antenna.
- Do not alter or remove tamper seals/tape from the equipment.
- Always use Ground Lugs as separate connections to chassis
- Always torque hardware to specified values.
- If mounting antenna near radar array, raise the VesseLINK™ Antenna approximately 15 degrees above radar array centerline and mount as far away as possible to reduce the possibility of interference.

Preparation

Prepare the VesseLINK™ Installation Kit as follows:

1. Unpack and lay out all components and parts.
2. Inspect for any damage
3. Conduct an inventory of all components and parts using the equipment packing list provided with the equipment. Any missing items and/or shipping damage should be reported immediately to Thales Customer Service Department (Tel: (800) 324-6089 or email customer.service@thalesdsi.com).

Precautions During Installation

The following steps should be followed to prevent damage to the equipment:

1. Keep dust cover over the SIM Card, once installed.
2. Do not disassemble or modify parts in installation kit unless instructed to do so.
3. Keep mounting hardware covered and protected until needed.

Installation

The following information covers the installation and set-up of the VesseLINK™ Above Deck Unit (ADU) / Antenna and the Below Deck Unit (BDU).

To complete the installation, you need the appropriate fasteners, tools, and mounts.



NOTE

Always wear safety goggles, ear protection, and a dust mask when drilling, cutting, or sanding. When drilling or cutting, always check first to see what is on the other side of surface. If you experience difficulty with the installation, contact Thales or seek the assistance of a professional installer.

Standard installation will be accomplished with the following installation hardware kits:

- ADU / Antenna Mounting Kit PN 1100791-501
- BDU Mounting Hardware Kit PN 1100789-501



NOTE

In the event of a new installation, pole mount brackets are available as an option. Templates are provided for any custom plates that need to be fabricated.

Mounting The Above Deck Unit (Antenna)

The VesseLINK™ antenna is designed to fit the optional Thales stainless steel antenna mounting plate. If replacing an existing L-band system, it may be possible to use the same mounting plate and hardware that is already in place. The VesseLINK™ has two sets of industry standard mounting configurations, each with four mounting points. Included in each kit are mounting templates if custom mounting hardware is necessary for your application.

It is important to note that the coaxial cable provided in the VesseLINK™ kit, or the Thales approved accessory coaxial cables, must be installed for proper operation of the VesseLINK™ system. Otherwise, the system may not calibrate correctly and will result in a failure at start-up. Install the cable using best practices for cable bend radius and to avoid pinching the cable. It is also important to ensure the cable does not get cut by or rub on nearby sharp objects. If an accessory cable is needed, refer to Table 1-3.

Keys to successful installation of the VesseLINK™ Antenna:

- Mount where antenna is at least the minimum safety distance away from vessel personnel (1.5 m).
- Mount antenna with unobstructed (Full View) of the sky (Figure 2-1). Any blockage to part of the sky by metal objects could result in loss of connection and/or poor data speeds.
- Mount antenna level (parallel) to Main Deck.

- Keep antenna away from large metallic surfaces when possible to increase performance.
- Mount as far away from other antennas (especially radar and magnetic compasses) as possible to avoid interference. See Figure 2-2 for recommendations on distance and horizontal displacement from radar arrays.
- Ground the antenna using a heavy ground cable (not included) from the ground terminal on the bottom of the antenna to the vessel's ground to protect the system from unwanted surges and voltage differentials.
- Use the supplied RF cable designed for VesseLINK™. Do not alter the provided cable prior to installation. It is mandatory to weather seal the connection at the antenna on permanent installations to prevent corrosion.
- Mounting should be in an area that minimizes vessel vibration

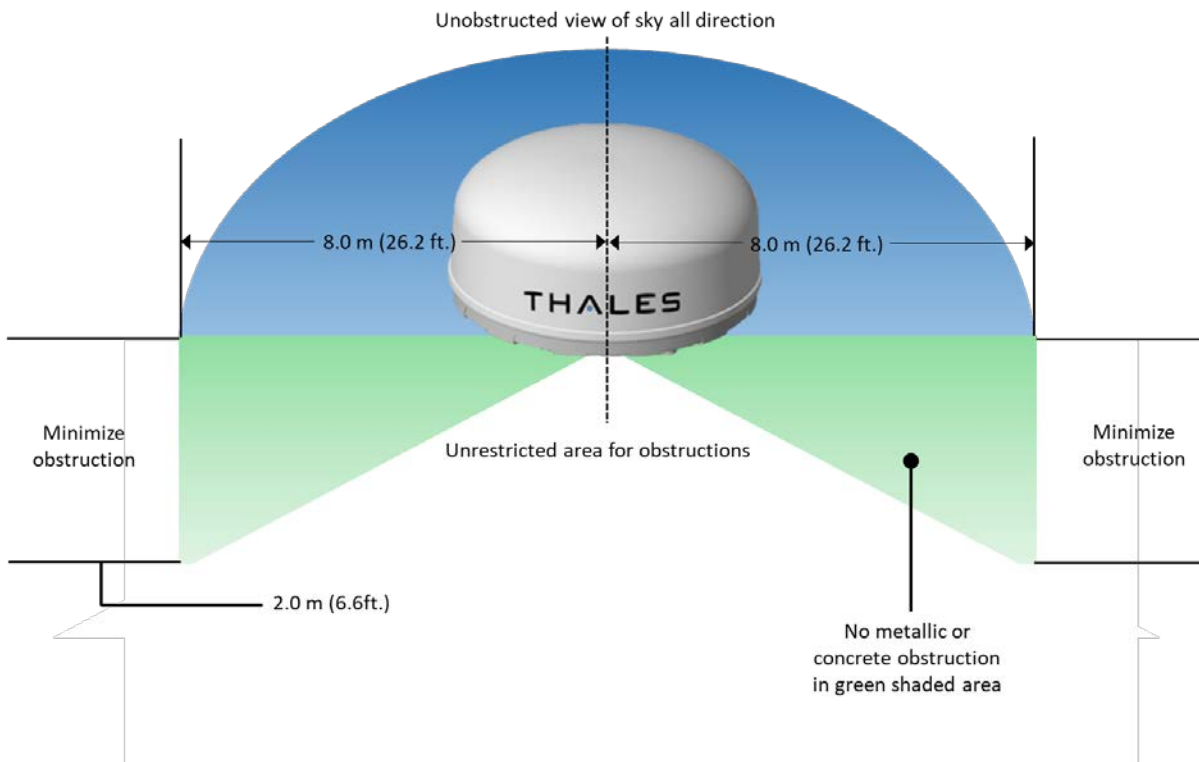
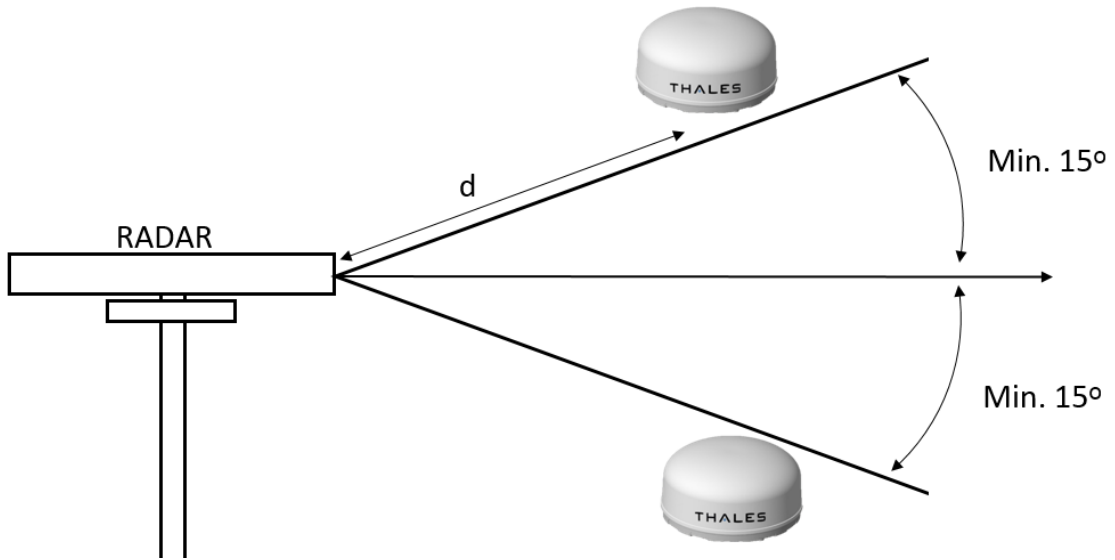

Figure 2-1 Placing Antenna for optimum performance



Distance

$d = 2.0\text{m}$ for S-Band up to 50kW

$d = 4.0\text{m}$ for X & C-Bands up to 50kW

Figure 2-2 Recommended Antenna Placement with Existing Radar

Installation of ADU / Antenna



NOTE

Prior to installing the ADU, it is important to determine which hardware is best suited for installation – M6 or M10 hardware. The Installation Kit (PN 1100791-501) contains mounting hardware for both types of installation.

Refer to the following paragraph, depending on the installation type required:

- Installation of ADU / Antenna using M6 Hardware
- Installation of ADU / Antenna using M10 Hardware



NOTE

The Antenna Mounting Template is provided in Appendix A for use in fabricating a custom plate. A mounting plate is not included in the kit, but Thales offers two pole mount brackets as accessory items. (Refer to Appendix C.)

The antenna is mounted with either four M6 (torque to 6 N*m (4.4 ft-lbs.)) or four M10 (torque to 28 N*m (20.6 ft-lbs.)) stainless steel bolts (included with KIT #1100791-501) as appropriate for the chosen mounting pattern on the base of the antenna. Anti-seize compound (included) should be applied to the stainless hardware immediately prior to installation.

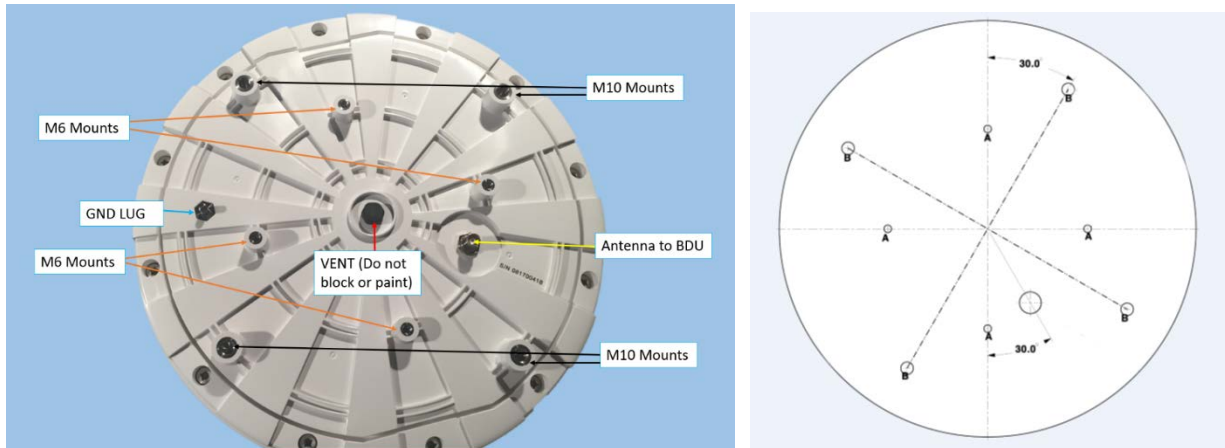

Figure 2-3: Mounting Holes in Bottom of Antenna and Mounting Template (Included In Kit)

Installation of ADU / Antenna using M6 Hardware

1. Use the template information provided in Appendix A to create the appropriate hole pattern in the desired mounting surface for the chosen mounting hardware.



NOTE

Hole sizing and provided hardware are shown for through hole mounting as shown in Appendix A. User may mount antenna with other hardware at their discretion and own risk.

2. Position the pattern to avoid interferences with the antenna or coaxial cable connection to the antenna.
3. Position the antenna in the proper orientation as decided by the pattern placement for the chosen mounting pattern on the base of the antenna (Refer to Appendix A).



NOTE

IMPORTANT: The antenna is mounted with four M6 (torque to 6 Nm (4.5 ft-lbs.)) stainless steel bolts (included with Antenna Mounting Hardware Kit PN 1100791-501) as appropriate for mounting plate thickness of .20 to .40 inches (5 to 10 mm.). **Never exceed the recommended torque values on mounting bolts as this will damage the unit.**



NOTE

Apply the supplied anti-seize to the hardware before assembly IF mounting to metallic plate incompatible with stainless steel hardware.

4. Assemble screws (1) with flat washers (3) and split lock washers (2) as shown in Figure 2-4 and torque to requirements.
5. Connect coaxial cable as shown in Figure 2-4 and hand tighten.
6. After connecting the cable to the antenna (Figure 2-4), wrap the connector with the self-vulcanizing tape to ensure a water-tight seal.
7. Run coaxial cable to approximate location of the BDU.

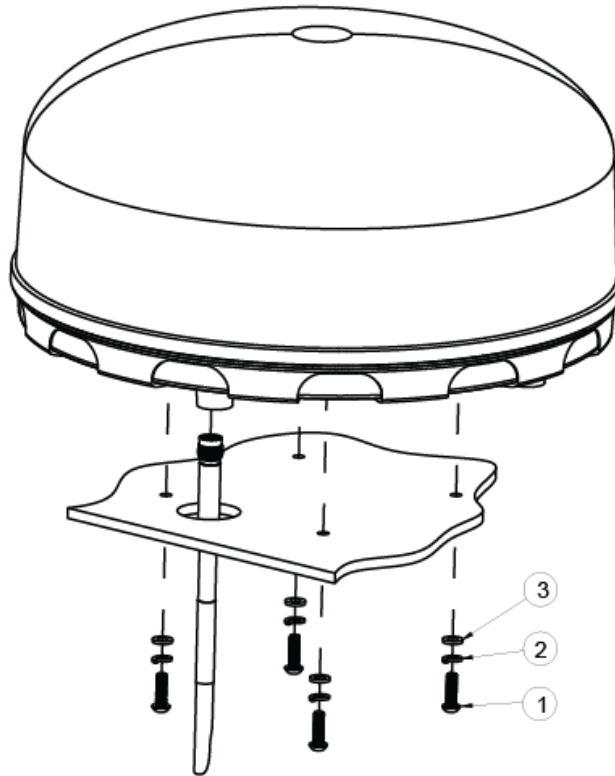

Figure 2-4 Above Deck Unit / Antenna Installation (M6 Hardware)

Table 2-1 Installation Kit, Mounting Hardware (M6 Hardware)

| Item Number | Description | Part Number | Qty |
|-------------|--|-------------|-----|
| 1 | Screw, Button HD Socket Cap M6x1x20mm A4-70 SS | 82771-001 | 4 |
| 2 | Washer, Split M6 (DIN 127B) A4 L/W SS | 71300-001 | 4 |
| 3 | Washer, Flat M6 A4-80 (DIN 125 ISO 7089) SS | 71299-001 | 4 |
| NI | Anti-Seize Lubricant, Loctite C5A Paste | 91383-001 | 1 |
| NI | Self-Vulcanizing Tape | 91384-001 | 1 |



Mounting Hardware Installation Kit (PN 1100791-501) contains additional hardware spares. The quantity listed in the above table reflect what is required for installation.

Installation of ADU / Antenna using M10 Hardware

1. Use the template information provided in Appendix A to create the appropriate hole pattern in the desired mounting surface for the chosen mounting hardware.



NOTE

Hole sizing and provided hardware are shown for through hole mounting as shown in Appendix A. User may mount antenna with other hardware at their discretion and own risk.

2. Position the pattern to avoid interferences with the antenna or coaxial cable connection to the antenna.
3. Position the antenna in the proper orientation as decided by the pattern placement for the chosen mounting pattern on the base of the antenna (Refer to Appendix A).



NOTE

IMPORTANT: The antenna is mounted with four M10 (torque to 28 Nm (21 ft-lbs.)) stainless steel bolts (included with Antenna Mounting Hardware Kit PN 1100791-501) as appropriate for mounting plate thickness of .20 to .47 inches (5 to 12 mm.). **Never exceed the recommended torque values on mounting bolts as this will damage the unit.**



NOTE

Apply the supplied anti-seize to the hardware before assembly IF mounting to metallic plate incompatible with stainless steel hardware.

4. Assemble screws (1) with flat washers (3) and split lock washers (2) as shown in Figure 2-5 and torque to requirements.
5. Connect coaxial cable as shown in Figure 2-5 and hand tighten.
6. After connecting the cable to the antenna (Figure 2-5), wrap the connector with the self-vulcanizing tape to ensure a water-tight seal.
7. Run coaxial cable to approximate location of the BDU installation location.

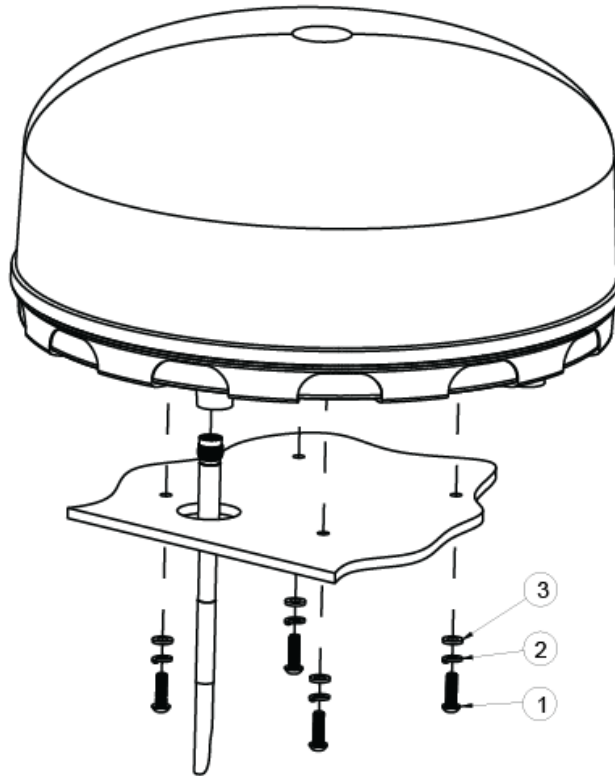

Figure 2-5 Above Deck Unit / Antenna Installation (M10 Hardware)

Table 2-2 Installation Kit, Mounting Hardware (M10 Hardware)

| Item Number | Description | Part Number | Qty |
|-------------|--|-------------|-----|
| 1 | Screw, Button HD Socket Cap M10x1.5x25mm A4-70 (ISO 7380) SS | 82770-001 | 4 |
| | Screw, Button HD Socket Cap M10x1.5x30mm A4-70 (ISO 7380) SS | 82770-002 | 4 |
| 2 | Washer, Split M10 MED L/W A4 (DIN 127B) SS | 71302-001 | 4 |
| 3 | Washer, Flat M10 (DIN 125) | 71301-001 | 4 |
| NI | Anti-Seize Lubricant, Loctite C5A Paste | 91383-001 | 1 |
| NI | Self-Vulcanizing Tape | 91384-001 | 1 |



Mounting Hardware Installation Kit (PN 1100791-501) contains additional hardware spares. The quantity listed in the above table reflect what is required for installation.

Installing The Below Deck Unit

The VesseLINK™ Below Deck Unit is designed for ease of installation with four corner mounting locations for direct mounting.



It is recommended that the BDU be mounted in a cool dry place leaving sufficient room (3 in. or 8 cm) between the BDU and other equipment to allow for proper airflow.

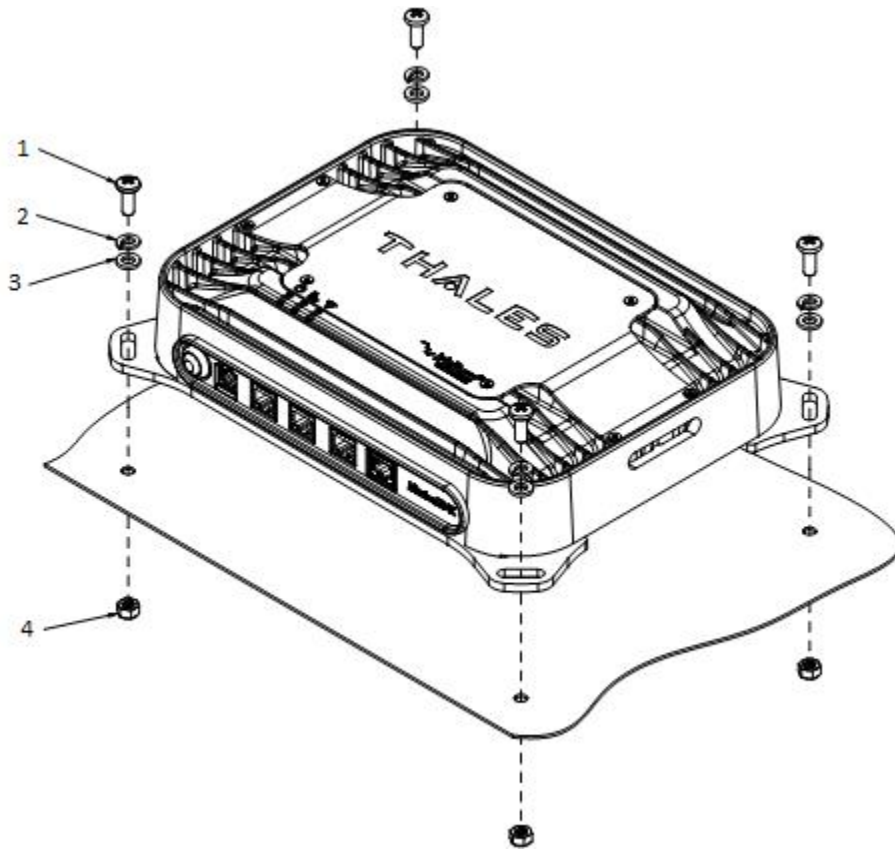

Figure 2-6 Below Deck Unit (BDU) Mounting Detail

Table 2-3 Installation Kit, Below Deck Unit (BDU) (PN 1100789-501)

| Item Number | Description | Part Number | Qty |
|-------------|--|-------------|-----|
| 1 | Screw Phil Pan HD 18-8 M6x1x16mm SS BLK Oxide | 82767-001 | 4 |
| | Screw Phil Pan HD 18-8 M6x1x20mm SS BLK Oxide | 82768-001 | 4 |
| 2 | Washer Split Lock M6 (DIN 127B) A4 SS BLK Oxide | 71304-001 | 4 |
| 3 | Washer Flat M6 6.4mm ID x 12mm OD x 1.6mm THK SS BLK Oxide | 71298-001 | 4 |
| 4 | Nut Lock w/Nylon Insert M6x1 18-8 SS | 75656-001 | 4 |

1. Use the template information provided in Appendix B to create the appropriate hole pattern in the desired mounting surface for the chosen mounting hardware.



NOTE

Hole sizing and provided hardware are shown for through hole mounting as shown in Appendix B. User may mount antenna with other hardware at their discretion and own risk.



NOTE

BDU can be mounted in any orientation but for best performance, it is recommended that it is mounted horizontally with the Thales logo facing up. This will give the best protection against any spills or dripping water and allows for the best heat transfer.

2. Position the pattern to avoid interferences with the antenna or coaxial cable connection to the antenna.
3. Assemble screws with split lock and flat washers as shown in Figure 2-6 and torque to 4.5 Ft. Lbs. (6 Nm).
4. Connect the provided Wi-Fi antenna, and install the SIM Card (from service provider) into slot.
 - a. Open the SIM Card protective cover by pulling it away from the TU, exposing the SIM card slot. (Figure 2-7).



Figure 2-7 SIM Card with Cover Opened

- b. Install SIM card from Air-time provider (1, Figure 2-8), by inserting the card with contacts down (2) until it clicks into place (3).
- c. Be sure to engage the lock for the SIM Card (4).

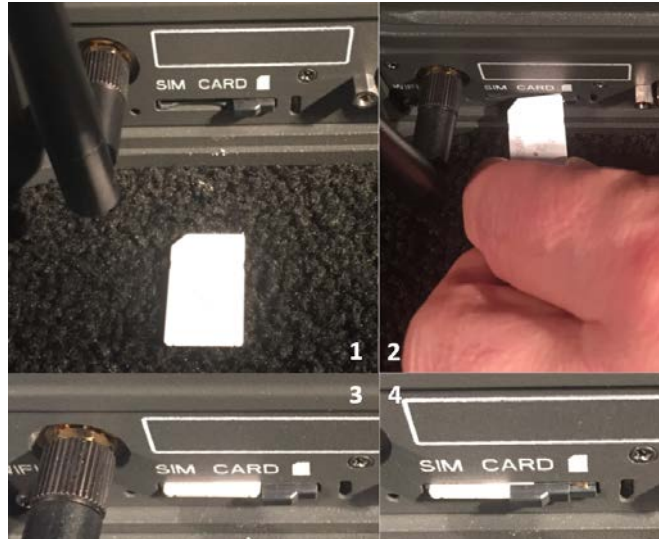

Figure 2-8 Installing SIM Card and Engaging the Lock

- d. Secure the SIM Card cover once the SIM Card has been locked into place to prevent moisture or dust intrusion. (Figure 2-9)



Figure 2-9 Secure the SIM Card Cover

- 5. Connect the provided RF cable that goes to the antenna.



NOTE

The BDU should be grounded. Use a 14 AWG (or larger) ground wire to connect the BDU to earth ground during normal use.

Connecting Power To The BDU

The BDU has 2 connections for direct power depending on the vessel power available:

- AC Operation: Supplied external AC/DC supply with power cord. (Refer to Figure 2-10)



Figure 2-10 AC/DC Power Supply



To safely disconnect the BDU from the power source, unplug the unit from the power outlet.

NOTE



When installing the BDU, the power outlet should be installed near the unit and be easily accessible.

NOTE

- DC Operation for vessels operating from battery power: 10-32 Volts DC (optional DC power cable available (Part # 855024-020):
 - RED + (10-32VDC)
 - BLACK – (GND)
 - Yellow (Remote Switch)
 - Turns BDU on/off through a remote switch connection or vessel ignition
 - Leave unconnected for BDU front panel switch operation on/off

DC Power Connection

Installations using the DC power cable (PN 855024-020) should use the red and black primary power wires as well as the yellow remote wire as the ON/OFF switching source. The BDU will turn OFF with the vehicle's ignition switch when the yellow remote line is connected, so it is important to make that connection in the vehicle (see Figure 2-11).

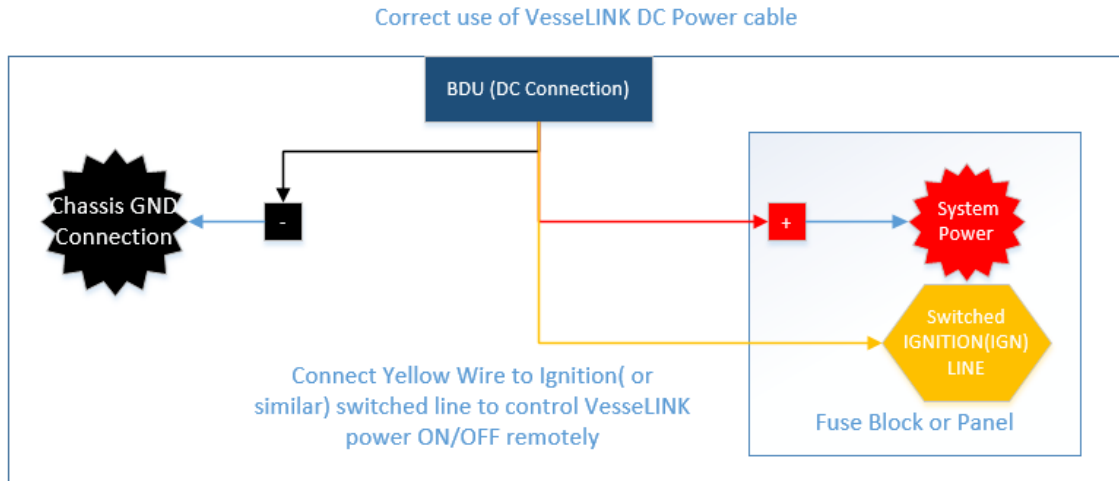

Figure 2-11 24V DC Power Connection

1. Connect the RED (+) cable to the positive terminal of DC power source.
2. Connect the BLACK (-) cable to the negative terminal of DC power source.



NOTE

Extra care and consideration must be taken when powering any device from a dual battery 24V DC system. It is important that 24V systems use the correct GND scheme that ensures unit is connected to the system's lowest potential (usually chassis GND). Otherwise damage to the BDU and antenna are likely and could void the warranty.

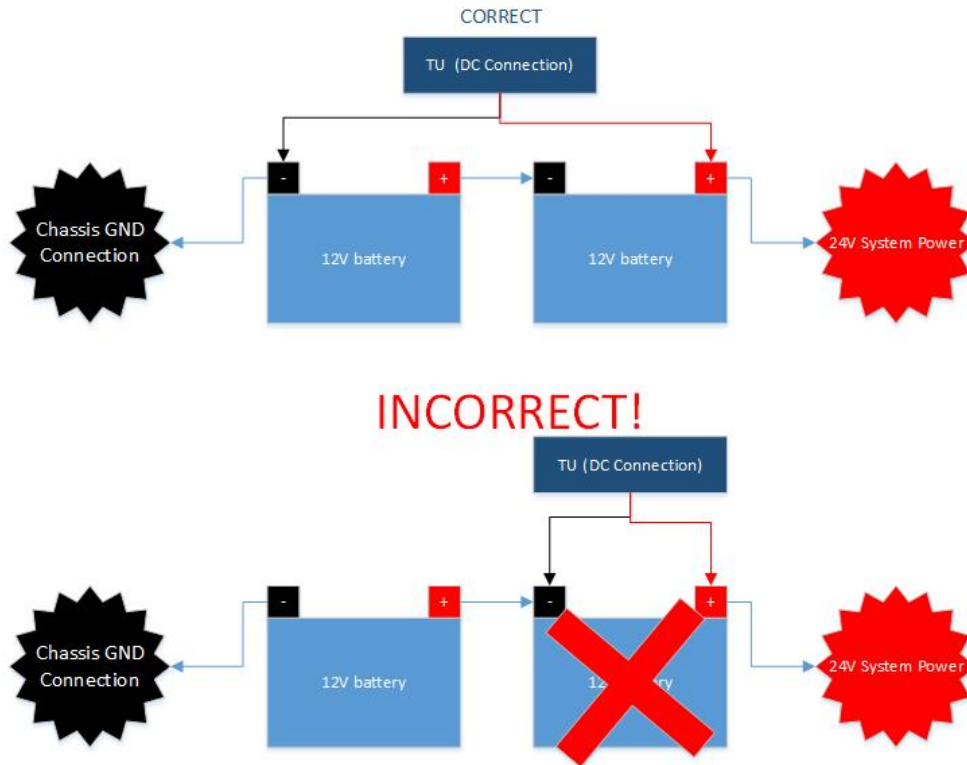

Figure 2-12 24V DC Power Connection

3. Connect the YELLOW wire to the ignition (or similar) via the fuse box or panel.

System Status Indicators

Now that the system installation is complete, press the start button on the BDU.

In Figure 2-13, from Left to Right these are: System (Overall System Status), Satellite (Satellite Connection Status) and Wi-Fi (Wireless Network Status).

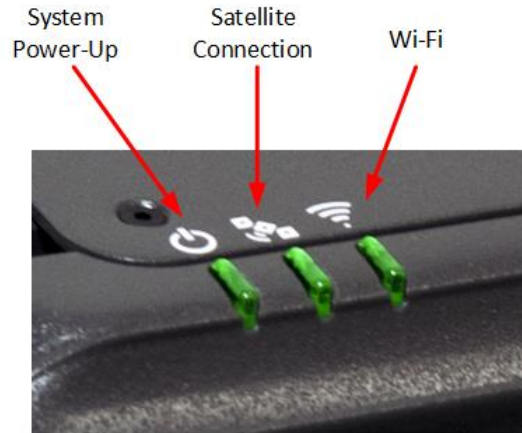





Figure 2-13 Below Deck Unit (BDU) LEDs

Table 2-4 Below Deck Unit (BDU) LED Status

| Indicator | Description |
|--|---|
|  System | |
| Solid GREEN | System functioning properly |
| Flashing GREEN | System busy (Booting up) |
| Solid RED | Fault (minor issue) |
| Flashing RED | Critical fault (major issue) |
|  Satellite | |
| Solid BLUE | Connected and passing data (over satellite) |
| Solid GREEN | System functioning properly |
| Flashing GREEN | Acquiring satellite |
| Solid RED | Fault (minor issue) |
| Flashing RED | Critical fault (major issue) |
|  Wi-Fi | |
| OFF | Wi-Fi OFF |
| Flashing GREEN | Wi-Fi busy |
| Solid Green | System functioning properly |
| Solid RED | Fault (minor issue) |
| Flashing RED | Critical fault (major issue) |



NOTE

The Indicator Colors are:

Solid Green: Operational

Flashing Green: start-up or in progress of configuring or acquiring service.

Solid Red: fault requires user attention (Open Management Portal for Alerts)





Flashing Red: critical fault requiring immediate attention. For additional information, refer to Chapter 3 Troubleshooting

THIS PAGE INTENTIONALLY LEFT BLANK

CHAPTER 3 TROUBLESHOOTING

TROUBLESHOOTING

Table 3-1 Troubleshooting

| PROBLEM | SOLUTION |
|--|--|
|  Satellite LED Flashing GREEN | <ul style="list-style-type: none"> Flashing GREEN light indicates that it is acquiring the satellite. If it continues to flash for more than 5 minutes, check that the antenna has a clear view of the sky. Reboot BDU. |
|  Satellite LED Flashing RED | <ul style="list-style-type: none"> Critical Fault Detected. Open Management Portal http://portal.thaleslink and check Alerts. Make any adjustments. (For example: check antenna connection, or GPS not acquired.) Turn unit off and on again. If same result, contact your service provider. |
|  System LED Flashing Green | <ul style="list-style-type: none"> Start-up in progress. Wait until unit has run diagnostics and completed start procedure. This may take more time than usual when acquiring satellites for the first time Switch power off and back on if the light doesn't turn solid green after 5 minutes. |
|  System LED Flashing RED | <p>Fault Detected. Open Management Portal http://portal.thaleslink and check for alerts. Make any adjustments. (For example: Common alerts include, but not limited to, are the SIM Card not installed, SIM Card not provisioned. Power-Up Test (POST) failure.)</p> <ul style="list-style-type: none"> Turn unit off and on again. If same result, contact your service provider. |
|  Wi-Fi LED | <p>OFF – Turn Wi-Fi ON using the Management Portal through a hardwired, PoE connection. ThalesLINK > Settings > Wi-Fi</p> <p>Solid RED – Wi-Fi may need to be turned off and back on again from the Management Portal. If the LED does not turn to GREEN within a minute, reboot the BDU.</p> <p>Flashing GREEN – If this continues for more than a minute or two, check for NO OR WEAK Wi-Fi</p> |
| Call Logs are not appearing | Call logs must be enabled. Verify call logs are enabled (SETTING → PHONE → PHONE CONFIGURATION) |
| Cannot connect to the internet | Data sessions default is OFF. Check to make Satellite Data Sessions is ACTIVATED on Dashboard. If not, select ACTIVATE and apply. |

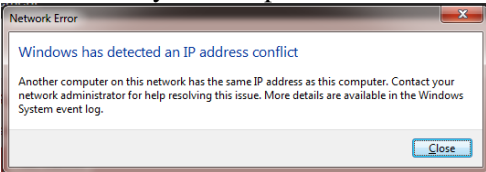
| PROBLEM | SOLUTION |
|---|---|
| Cannot connect to the Management Portal | <ul style="list-style-type: none"> • Ensure Terminal Unit is powered ON • Ensure Wi-Fi is enabled and connected to ThalesLINK (or renamed SSID). If using a Wi-Fi enabled device, the Wi-Fi LED on the BDU should be solid GREEN. If not using Wi-Fi, ensure Cat 5 cable is connected to one of the three Ethernet ports (NOT WAN or POTS Port). If Ethernet connection, replace the cable and re-check connection • Open web browser and type http://portal.thaleslink/#. Ensure network settings are correct on the connected device. • Device's browser may be incompatible. Update or try different browser. • You may need to reconnect via Ethernet or Wi-Fi to the TBDU. • Check to make sure the correct address is typed in http://portal.thaleslink • If system LED is flashing GREEN, wait until it turns solid GREEN, then try reconnecting to the portal. |
| Cannot connect to Wi-Fi service | <ul style="list-style-type: none"> • Check that the Wi-Fi antenna is attached and tightly screwed in. • Check that the BDU's Wi-Fi LED is solid GREEN. • Check to see if there's an available connection by checking the devices that are connected in Status → Current Devices page. • Only 5 simultaneous devices can connect to the Wi-Fi. Any additional connection attempts are blocked. • Remove one or more devices from the Wi-Fi and try again to connect. • Use the Wi-Fi Device Whitelist to limit access to specific wireless devices. |
| Network Error | <p>If you receive a message similar to this, another user is attempting to use the same IP Address as your computer.</p>  |
| No or Weak Wi-Fi Signal | <ul style="list-style-type: none"> • Connect Wi-Fi antenna and ensure it is secured tightly • If walls or metal obstructions are between the BDU and the Wi-Fi device, move closer to the BDU or move the BDU to a better location with less obstructions • Check to make sure Wi-Fi device is connected to the BDU's Wi-Fi and verify that you are connected to the ThalesLINK. • Check the Management Portal to make sure the Wi-Fi device is registered as a user. |

| PROBLEM | SOLUTION |
|--|---|
| <p>ThalesLINK is not obtaining a satellite signal (Satellite LED is red)</p> | <ul style="list-style-type: none"> • Check signal bars at the top of the Management Portal. If no bars are highlighted, the satellite is not being detected. Wait a few minutes to see if the signal strength improves as another satellite comes into view. • Check antenna connection at the BDU and antenna. Make sure no corrosion has occurred on the cable connections to the antenna and that the connectors are screwed in tightly. • Check antenna for a clear view of the sky with no obstructions. Relocate antenna if needed. • Check for interferers in the area that could be affecting the signal such as active radars, VSAT systems and other radio antennas. Turn those off and retest. • Move vehicle to a new location and retest if other interfering vehicles are in the area • Reboot BDU and check the Alerts. • Call Service Provider if the satellite connection is still not working. |
| <p>Terminal Unit does not Power-ON</p> | <ul style="list-style-type: none"> • Check BDU for Green lights, If green light is on Unit has Power • Push power button on front of BDU. • Check that the power source is providing 10-32V and is not current limited. • Check connection of the 10-32V DC cable has correct polarity. • Check to ensure Ignition line is connected to switched line or connected to Red (Positive line) for continuous operation. • Check that ignition or remote switch is turned on if ignition line is connected. • If using AC/DC converter (optional), make sure the AC outlet has power and that the plug is securely in the AC outlet and the other end is securely connected to the BDU. |
| <p>Terminal Unit has power but accessories not working</p> | <ul style="list-style-type: none"> • Remove power from accessories and disconnect from BDU. Restart BDU using the power button or remove power from BDU for 10 seconds. After BDU has rebooted re-attach accessories • If PoE accessory not receiving power, make sure PoE is enabled for that port. • PoE is not available on WAN port. Any device on WAN port needs its own power source. • Check VoIP phone manuals for proper configuration. Each phone may have a different configuration method. |

| PROBLEM | SOLUTION |
|---------------------------------|---|
| Terminal Unit is not responding | <ul style="list-style-type: none"> • Check LED status on BDU or on Management Portal. Make sure there are no RED LEDs. Check for Alerts in Management Portal by selecting the Alerts menu item • Reboot the system and recheck for any Alerts that have been generated. • Call Service Provider if the BDU is still not responding. • As a last resort, use the manual reset button, located below Wi-Fi antenna port, using a straightened paper clip or similar sized article insert into port and push reset button. <p><u>NOTE:</u> This is not recommended as a routine troubleshooting measure. All user data and debug information will be lost and factory defaults returned.</p> |

CHAPTER 4 TECHNICAL SPECIFICATIONS

Technical Specifications

Table 4-1 Technical Specifications

| RF Performance | | |
|-------------------------|--|--|
| Frequency of Operation | TX | 1616 to 1626 MHz |
| | RX | 1616 to 1626.5 MHz |
| Channelization | FDMA spacing | 41.667 KHz |
| | TDMA Timing | 8.3 mS Slot in a 90 mS window |
| | Channels Available | 240 channels |
| EIRP (Weighted Average) | Voice | 9 dBW |
| | Data (Block 1) | 11.7 dBW |
| | Data Certus SM 1xC8 16 APSK | 15.2 dBW |
| | Data Certus SM 2xC8 16 APSK | 18.2 dBW |
| Modulation | Block 1 Voice/Data | DQPSK |
| | Certus SM C1, C8 Voice/Data | QPSK |
| | Certus SM C8 APSK Data | 16 APSK |
| Antenna | Type | Electronically steered phased array |
| | Polarization | RHCP |
| | Gain | 9.5 dBi |
| | Beam Width | 31° typical per beam |
| | VesseLINK TM coverage | provides useful link margin up to roll = 20° |
| Power | | |
| Main Power (AC Brick) | AC Input Voltage | 100-240 VAC |
| | Frequency | 50/60 Hz |
| | DC Output Voltage | 12 VDC |
| | Max Power | 120W |
| DC Input 10-32 VDC | Voltage | 10-32 VDC |
| | Max Current | 12 Amps (10V) – 3.75 Amps (32V) |
| | Max Power | 120 Watts |
| DC Input 12 VDC | Voltage | 12 VDC (+10%/-5%) |
| | Max Current | 10 Amps |
| | Max Power | 120 Watts |
| Ethernet | 3x PoE | PoE Class 2 (6.5 Watts each) |

| Environmental | | |
|----------------------|-----------------|----------------------------------|
| ADU | Operating Temp | -30°C to +55°C |
| | IP Rating | IP67 |
| BDU | Operating Temp | -30°C to +55°C |
| | IP Rating | IP31 |
| Mechanical | | |
| ADU | Diameter | 14.5" (36.8cm) |
| | Height | 7.5" (19.8cm) |
| | Weight | 7 lbs (3.2kg) |
| BDU | Length | 12 inches (30cm) |
| | Width | 9 inches (23cm) |
| | Height | 3 Inches (7.6cm) |
| | Weight | 7.5 lbs (3.4kg) |
| AC Power Brick | Length | 6.6" (16.7cm) |
| | Width | 2.6" (6.7cm) |
| | Height | 1.4"(3.5cm) |
| | Weight | 1.37lbs (0.62 kg) |
| | AC Cable Length | ~6ft (1.8m) |
| | DC Cable Length | ~3.9ft (1.2m) |
| RF Cables | 25 meter | LMR-300FR or Similar w/TNCM-TNCM |

Connector Details:

General Purpose Inputs / Outputs (GPIO)

The DB-15 connector with Pin out shown in Figure 4-1.

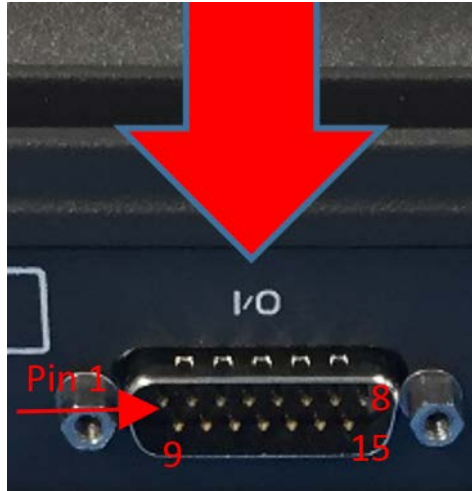

Figure 4-1 GPIO Connector Pin Detail

Table 4-2 GPIO Connector Pin Definition

| Pin No | Name | Description |
|--------|-------------|--|
| 1 | GND1 | Ground |
| 2 | Audio_In + | Radio Gateway functionality, differential (+) Hi-Z Audio Input from external Radio |
| 3 | Audio_Out + | Radio Gateway functionality, Differential (+) Low-Z Audio Output to external radio (mic input) |
| 4 | RadioCOR | Radio Gateway functionality, Radio initiated voice into terminal (optional) |
| 5 | SOS_IN | SOS remote functionality, Ground pin to activate internal SOS |
| 6 | GPI01 | Software configurable GPIO pin #1 (future) |
| 7 | RS232_TD | RS232 Output (future) |
| 8 | GND2 | Ground |
| 9 | Audio_In - | Radio Gateway functionality, differential (-) Hi-Z Audio Input from external Radio |
| 10 | Audio_Out - | Radio Gateway functionality, Differential (-) Low-Z Audio Output to external radio (mic input) |
| 11 | RadioPTT | Radio Gateway functionality, Output PTT from terminal to external radio, short to ground for PTT enabled, Open drain requires external 10k pullup resistor |
| 12 | GND3 | Ground |
| 13 | GPI02 | Software configurable GPIO pin #2 (future) |
| 14 | RS232_RD | RS232 Input (future) |
| 15 | 12V | +12V output, 100mA |

BDU 12V Connection Detail

Type: KPPX-4x connector (or similar) shown in Figure 4-2.

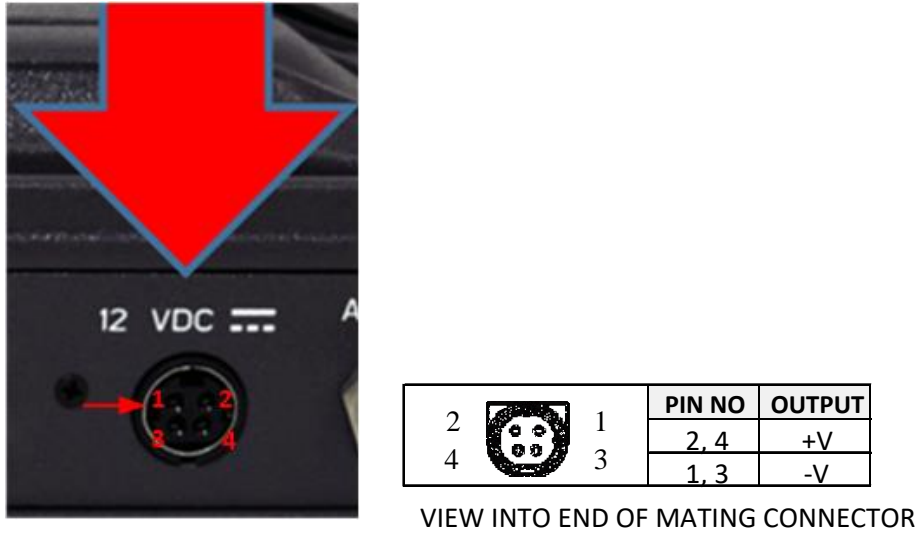

Figure 4-2 12V Input and Mating Connector Detail

BDU 10-32VDC Connection Detail

Type: 684M7W2103L201 connector (or similar) shown in Figure 4-3.

A1 = V+ /10-32VDC

A2 =V- /GND

Pin 5 = Ignition

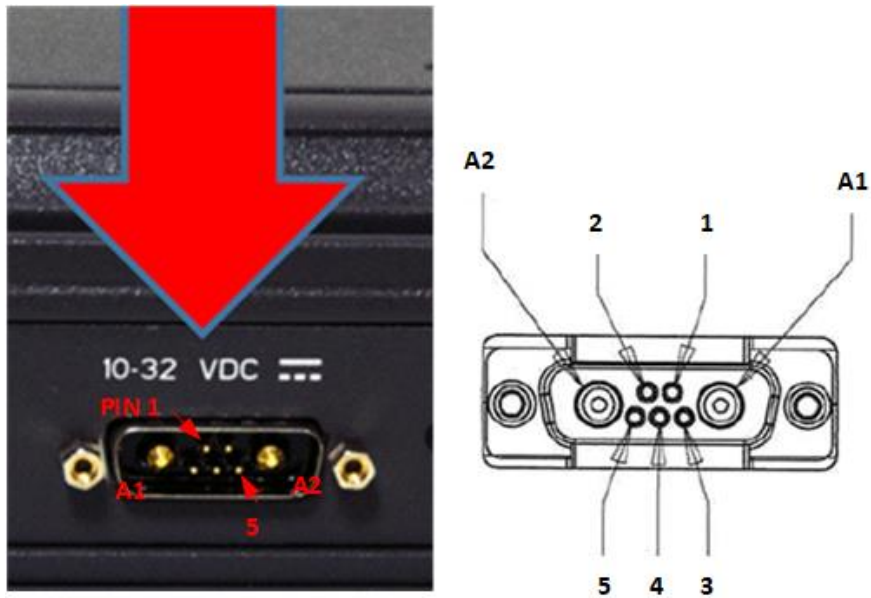

Figure 4-3 10-32 VDC and Mating Connector Detail

CHAPTER 5 ACRONYMS / GLOSSARY

Acronyms / Glossary

Table 5-1 List of Acronyms

| Acronym | Description |
|----------------|---|
| ADU | Above Deck Unit Antenna |
| API | Application Programming Interface |
| BAA | Broadband Active Antenna |
| BAE | Broadband Application Electronics |
| BCX | Broadband Core Transceiver |
| BDU | Below Deck Unit Terminal Unit |
| BIT | Built In Test |
| DTMF | Dual Tone Multi-Frequency |
| EBB | Enhanced Broadband |
| ETSI | European Telecommunications Standards Institute |
| GPIO | General Purpose Inputs/Outputs |
| HGA | High Gain Antenna |
| HRLP | High Speed Radio Link Protocol |
| HTTP | Hypertext Transfer Protocol |
| IP | Internet Protocol |
| ICMP | Internet Control Message Protocol |
| ITU | International Telecommunications Union |
| LAN | Local Area Network |
| LED | Light Emitting Diode |
| LGA | Low Gain Antenna |
| MO | Mobile Originated |
| msec | Milliseconds |
| MT | Mobile Terminated |
| NAS | Network Attached Storage |
| PBX | Private Branch Exchange |
| PCM | Pulse Code Modulation |
| PoE | Power Over Ethernet |
| POST | Power On Self-Test |
| POTS | Plain Old Telephone Service |
| PSTN | Public Switched Telephone Network |
| PTT | Two way radio term indicating the pressing of a button to initiate transmit before speaking |
| R/W | Read/Write |
| SBC | Smart Battery Charger |
| SIM | Subscriber Identity Module |
| SIP | Session Initiation Protocol |
| SMBus | System Management Bus |

| Acronym | Description |
|----------------|---|
| SV | Satellite Vehicle |
| TCP | Transmission Control Protocol |
| TU | Terminal Unit |
| UDP | User Datagram Protocol |
| UL/DL | Uplink/Downlink |
| VLAN | Virtual Local Area Network |
| VOIP | Voice of Internet Protocol |
| WAN | Wide Area Network |
| WI-FI | Wireless Network |
| WPA2-PSK | Wi-Fi Protected Access 2 – Pre-Shared Key |

Table 5-2 List of Definitions

| Acronym | Description | |
|----------------|---|---|
| API | Application Programming Interface | The Management Portal provides API to allow for the connection to the terminal remotely. |
| BAA | Broadband Active Antenna | The antenna and supporting electronics that interface an Iridium satellite terminal with the Iridium constellation |
| BAE | Broadband Application Electronics | Hardware and software platform resident in the BDU that interfaces with the BCX, BAA and user devices |
| BCX | Broadband Core Transceiver | Hardware designed for an Iridium satellite terminal to interface end-user equipment with an Iridium BAA |
| BIT | Built In Test | Diagnostic testing for system integrity check and error reporting |
| DTMF | Dual Tone Multi-Frequency | Signals generated from phone keypad |
| EBB | Enhanced Broadband | EBB Mode is Iridium NEXT phase 1 EBBS (Enhanced Broadband Service) |
| ETSI | European Telecommunications Standards Institute | Organization that maintains standards for Information and Communications applicable to fixed and mobile radio platforms |
| GPIO | General Purpose Inputs/Outputs | General use pins |
| HGA | High Gain Antenna | External antenna that connects to the BDU via a coaxial cable. The HGA2 (also called BAA-H2) provides 352 kbps uplink and downlink capability |
| HRLP | High Speed Radio Link Protocol | Management of In-band signaling on broadband channels |
| HTTP | Hypertext Transfer Protocol | Protocol to exchange or transfer hypertext |
| ICMP | Internet Control Message Protocol | Protocol by network devices that typically send error messages and is used for diagnostics |
| ITU | International Telecommunications Union | Agency of the United Nations responsible for issues concerning information and communications technologies |
| LED | Light Emitting Diode | Semiconductor that emits colored light |

| Acronym | Description | |
|-------------------|---|---|
| LGA | Low Gain Antenna | External antenna that connects to the BDU via a coaxial cable. The LGA1 and LGA2 support the future Certus SM 100 and Certus SM 200 capabilities |
| Management Portal | | Management Portal: A web page served from the Terminal Unit that brings together the diverse status and configuration information of the LMC 350 in one place. |
| MO | Mobile Originated | Calls originating from the terminal) |
| MT | Mobile Terminated | Calls terminating at the terminal |
| NAS | Network Attached Storage | Ability to store and retrieve files to/from a physical memory storage device attached to the network |
| PBX | Private Branch Exchange | Telephone connection between local users not requiring external phone connection |
| POST | Power On Self-Test | BIT Test performed at the turn-on of the BDU |
| POTS | Plain Old Telephone Service | A voice-grade telephone service that utilizes analog signal transmission over copper loops |
| PSTN | Public Switched Telephone Network | The world's collection of interconnected voice-orientable public telephone networks, both commercial and government owned. |
| PTT | Push-To-Talk | Two way radio term indicating the pressing of a button to initiate transmit before speaking |
| R/W | Read/Write | Capability |
| RGW | Radio Gateway | Radio Gateway feature enables communication between telephone users and users of ground radios. |
| SIM | Subscriber Identification Module | Iridium provided method to authenticate and identify subscriber |
| SIP | Session Initiation Protocol | An Internet Engineering Task Force (IETF) standard protocol for initiating an interactive user session that involves multimedia elements such as video, voice, and chat |
| SV | Satellite Vehicle | Iridium Satellite |
| SMBus | System Management Bus | Two-wire bus for communications between devices such as a Terminal and a Smart Battery |
| TCP | Transmission Control Protocol | Core internet protocol that provides reliable delivery and error-checking |
| TU | Terminal Unit | Electronic equipment that contains the BCX and the BAE |
| UL/DL | Uplink/Downlink | To and from satellite communications |
| UDP | User Datagram Protocol | Connectionless transmission model with minimum , no-handshaking protocol |
| VLAN | Virtual Local Area Network | For context within this document, VLAN more specifically designates an Ethernet VLAN. A VLAN is establishes a broadcast domain that is partitioned |
| WPA2-PSK | Wi-Fi Protected Access 2 – Pre-Shared Key | Method of securing a Wi-Fi network |

THIS PAGE INTENTIONALLY LEFT BLANK

INDEX

A

Acronyms / Glossary..... 5-1

C

Connectors

BDU 10-32VDC Connector..... 4-4

BDU 12V Connector..... 4-4

General Purpose Inputs/Outputs (GPIO) 4-3

E

Equipment Overview 1-1

I

Installation

ADU / Antenna 2-5

ADU / Antenna using M10 Hardware 2-8

ADU / Antenna using M6 Hardware 2-6

Connecting Power to the BDU 2-13

Installing the Below Deck Unit..... 2-10

List of Tools and Supplies Needed 1-7

Mounting the Above Deck Unit / Antenna 2-2

System Status Indicators 2-16

Introduction..... 1-1

K

Kit Components

VesseLINK™ 1-6

M

Maintenance

Troubleshooting 3-1

S

System Overview

| | |
|------------------------------|-----|
| Above Deck Antenna Unit..... | 1-5 |
| Below Deck Unit (BDU) | 1-2 |

T

| | |
|--------------------------------|-----|
| Technical Specifications | 4-1 |
|--------------------------------|-----|

NOTES: UNLESS OTHERWISE SPECIFIED.

1. INTERPRET DRAWING PER ASME Y14.100-2013.
2. INTERPRET DIMENSIONS AND TOLERANCES PER ASME Y14.5-2009.
3. DETERMINE IF METHOD OF MOUNTING WILL USE M6 (HOLE A) OR M10 (HOLE B) HARDWARE.

4. IMPLEMENT APPROPRIATE HOLE OR HARDWARE PREPARATION AT INDICATED POSITIONS FOR CHOSEN MOUNTING METHOD AND HARDWARE. THROUGH HOLE DIMENSIONS SHOWN ARE SUGGESTED FOR SUPPLIED M6 OR M10 HARDWARE.

5. IF THIS DOCUMENT IS PRINTED OR REPRODUCED, USER MUST VERIFY SCALE THROUGH MEASUREMENT OF X AND Y AXES ON SCALE CHECK PROVIDED

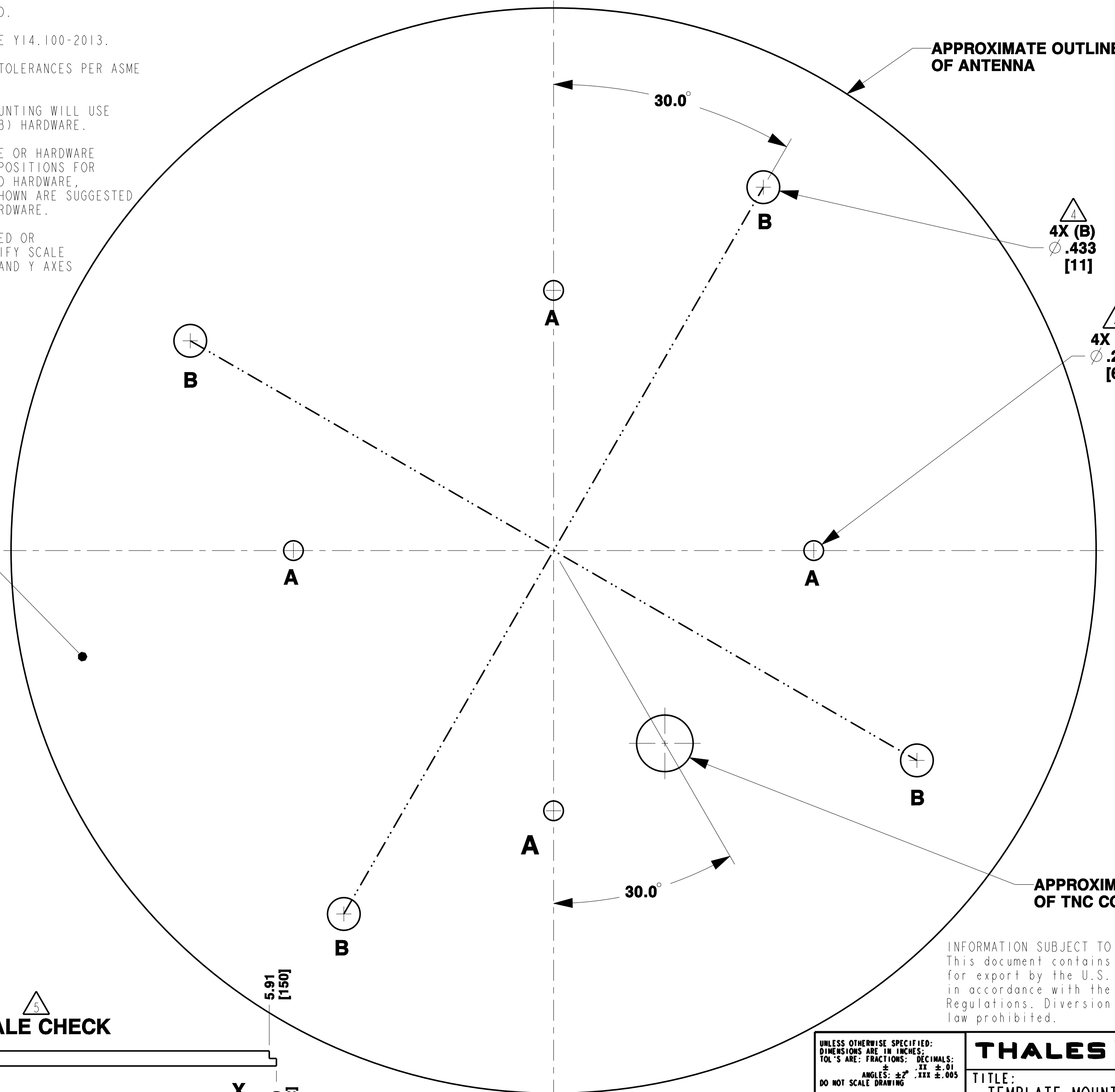

APPROXIMATE OUTLINE OF ANTENNA

4X (B)
Ø .433
[11]

4X (A)
Ø .260
[6,6]

SURFACE FACING ANTENNA WHEN MOUNTED

6.00 [152]
5.91 [150]

SCALE CHECK

.00 [0]
6.00 [152]

6.00 [152]
5.91 [150]

APPROXIMATE LOCATION OF TNC CONNECTOR

INFORMATION SUBJECT TO EXPORT CONTROL LAWS
This document contains technology controlled for export by the U.S. Department of Commerce in accordance with the Export Administration Regulations. Diversion contrary to U.S. law prohibited.

| | |
|---|----------------|
| UNLESS OTHERWISE SPECIFIED: DIMENSIONS ARE IN INCHES: TOL'S ARE: FRACTIONS: DECIMALS: ± .01 DO NOT SCALE DRAWING | |
| STATE: Released | |
| ITERATION: A.3 | DATE: 06-12-17 |
| DRAWN: DAH | |

| | |
|---|------------------|
| THALES THALES DEFENSE & SECURITY, INC. CLARKSBURG, MARYLAND 20871 | |
| TITLE: TEMPLATE MOUNTING MARITIME BAA | |
| SIZE: C | CAGE CODE: 23386 |
| DWG. NO.: 3900014 | REV: A |
| SCALE: 1.000 | SHEET: 1 of 1 |

NOTES: UNLESS OTHERWISE SPECIFIED.

1. INTERPRET DRAWING PER ASME Y14.100-2013.
2. INTERPRET DIMENSIONS AND TOLERANCES PER ASME Y14.5-2009.
3. OVERLAY THIS TEMPLATE ON INTENDED MOUNTING SURFACE
4. DETERMINE DESIRED POSITION OF MOUNTING FASTENER IN EACH OF THE FOUR CORNERS WITHIN BOUNDARY OF MOUNTING SLOT. CENTER MARKS (+) WITHIN EACH SLOT DEPICT ONE CENTER POSITION AND THE LIMITS FROM SIDE TO SIDE WHICH MAY BE USED AS FASTENER POSITIONS.
5. PREPARE HOLES APPROPRIATE FOR CHOSEN MOUNTING METHOD OR HARDWARE. 6.6MM THROUGH HOLES RECOMMENDED IF SUPPLIED HARDWARE IS USED.
6. IF THIS DOCUMENT IS PRINTED OR REPRODUCED, USER MUST VERIFY SCALE THROUGH MEASUREMENT OF X AND Y AXES ON SCALE CHECK PROVIDED.

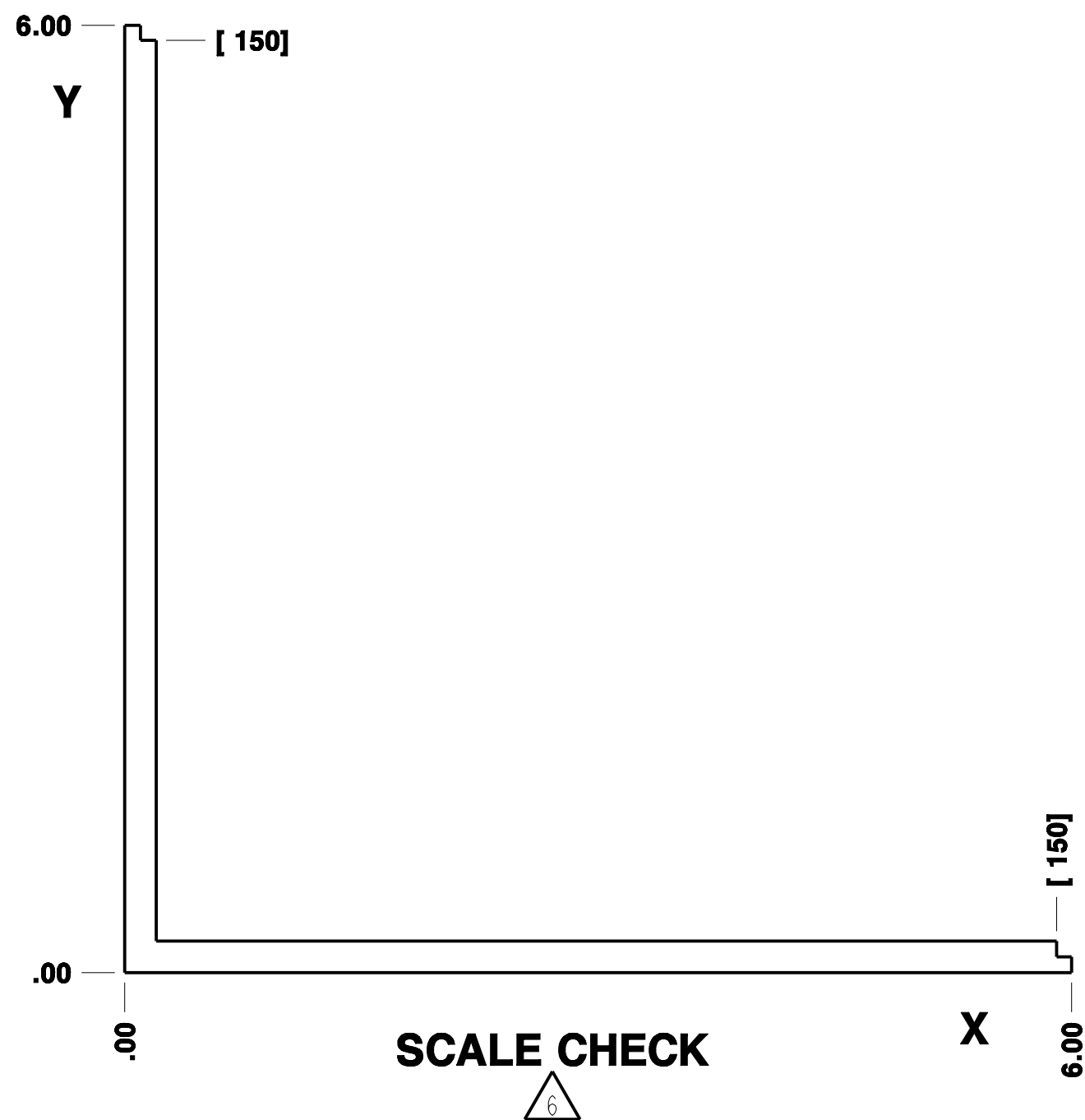

SCALE CHECK

CENTER AND LIMIT HOLE LOCATIONS



4X

APPROXIMATE OUTLINE OF TERMINAL UNIT BASE

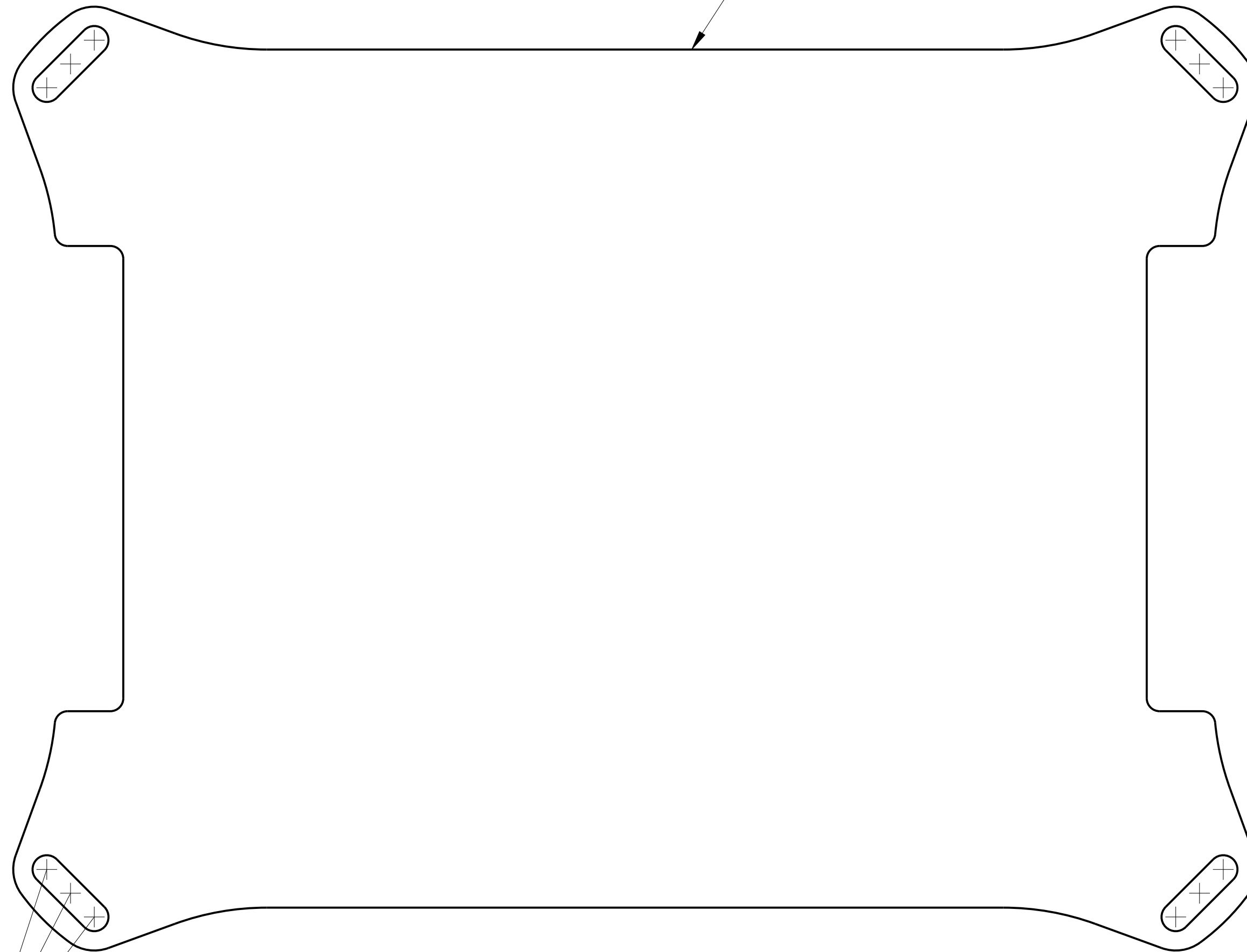

DIMENSIONS IN INCHES [MILLIMETERS]

INFORMATION SUBJECT TO EXPORT CONTROL LAWS
 This document contains technology controlled for export by the U.S. Department of Commerce in accordance with the Export Administration Regulations. Diversion contrary to U.S. law prohibited.

Copyright © 2018, Thales Defense & Security, Inc.
 All Rights Reserved

THALES PROPRIETARY

| | | | |
|--|----------------|---|-------------------|
| UNLESS OTHERWISE SPECIFIED: DIMENSIONS ARE IN INCHES: TOL'S ARE: FRACTIONS: DECIMALS: ± . XX ±.01 ± .XXX ±.005 DO NOT SCALE DRAWING | | THALES THALES DEFENSE & SECURITY, INC. CLARKSBURG, MARYLAND 20871 | |
| STATE: Released | | TITLE: TEMPLATE TERMINAL UNIT MOUNT | |
| ITERATION: B.2 | SIZE: C | CAGE CODE: 23386 | DWG. NO.: 3900011 |
| DRAWN: DAH | DATE: 05-05-17 | SCALE: 1.000 | REV: B |
| | | SHEET: 1 of 1 | |

Appendix C Antenna Pole Mounting (Optional)

An optional 316 stainless steel antenna mounting bracket is available.

- Antenna Pole Mount M6 (PN 85736-001)
- Antenna Pole Mount M10 (PN 85739-001)

The bracket is designed to work on standard 1.9-inch (with included bushing), 52mm and 3-inch poles (poles not included). This bracket has mounting holes that match the mounting points on the bottom of the antenna (M6 or M10).

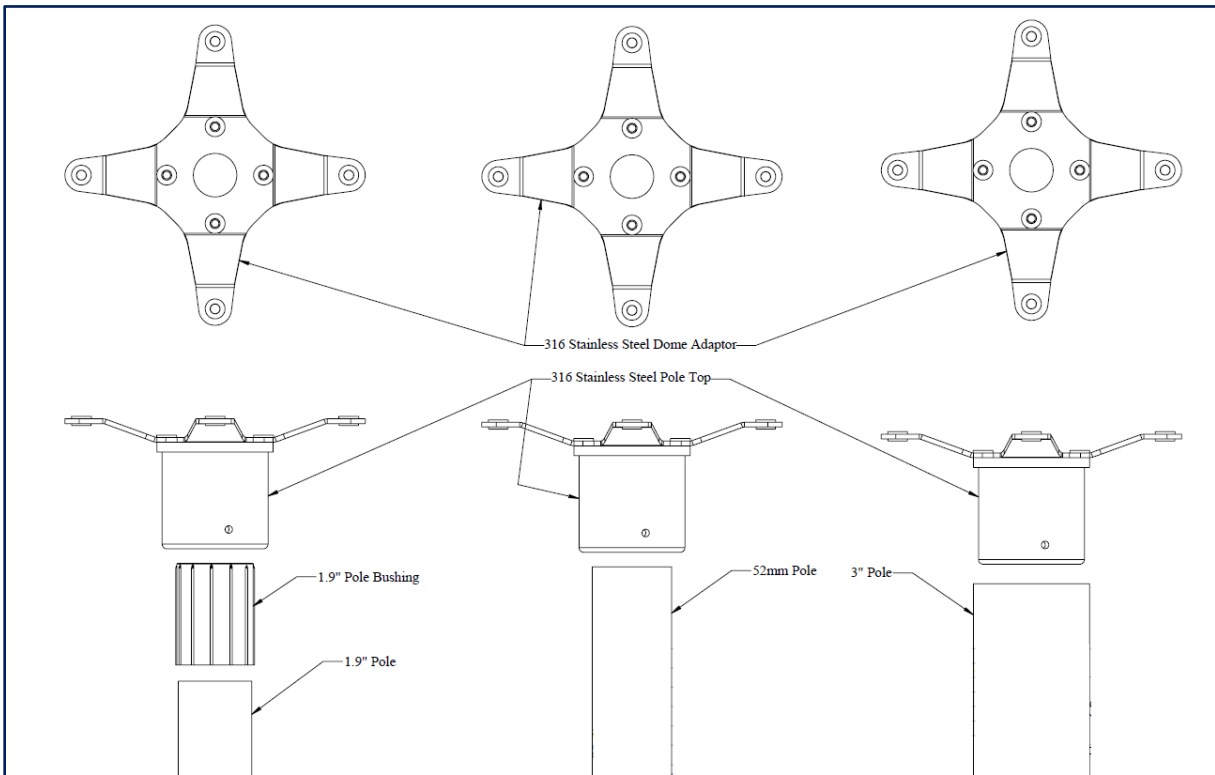

Figure C-1 Thales Antenna Mounting Bracket (Shown With Poles, Not Included)

Antenna Pole Mount using M6 Hardware

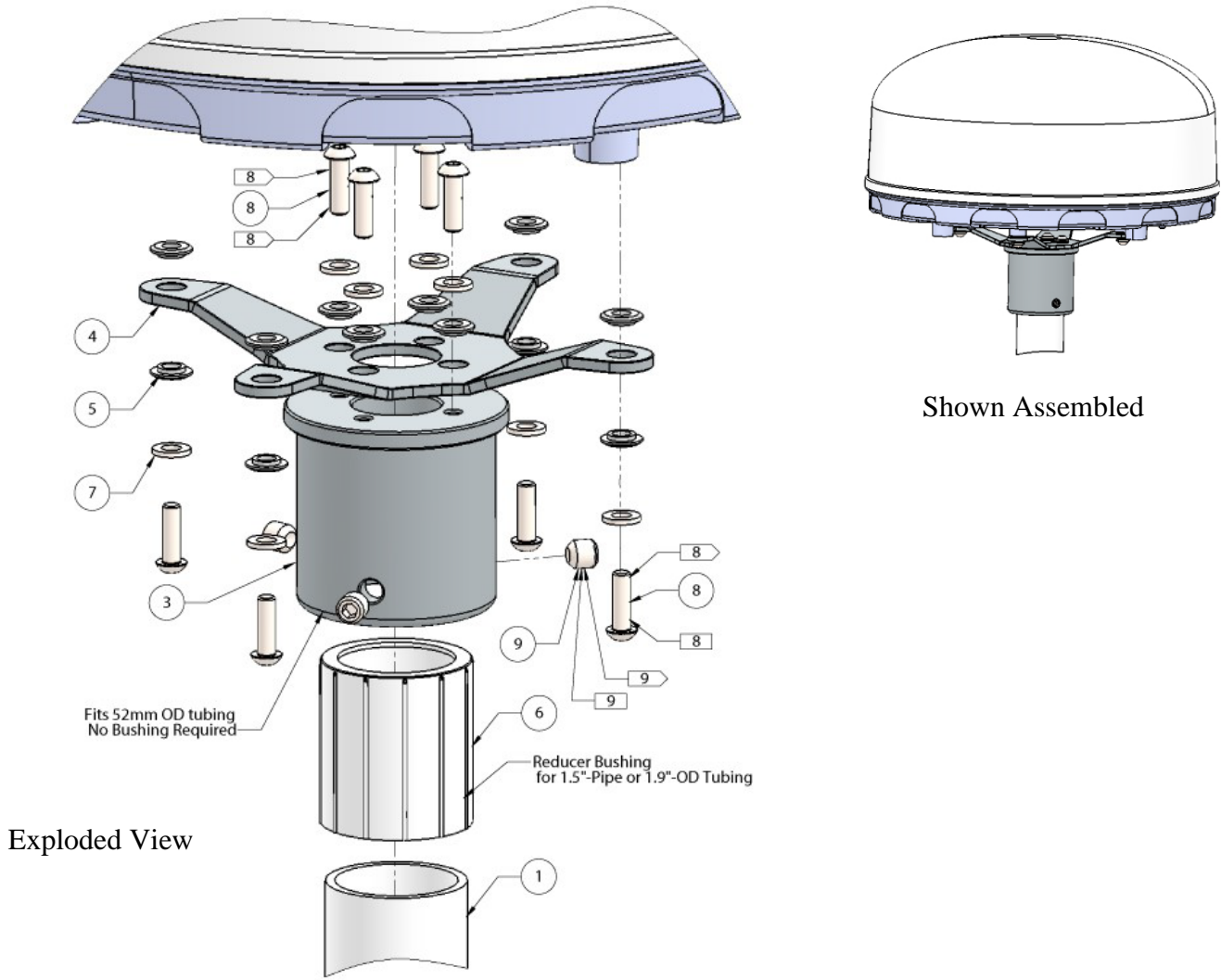

Figure C-2 Thales Antenna Pole Mount Kit – M6 (PN 85736-001)

Table C-1 Antenna Pole Mount using M6 Hardware Kit (PN 85736-001)

| Item Number | Description | Qty | Comment |
|-------------|---|-----|--------------------------|
| 1 | Outside Diameter 1.9" OD | 1 | |
| 2 | Blue Loctite | 1 | Apply to item 8, 9 |
| 3 | S.S. Hub 52mm-ID for Metric 52mm Tube | 1 | |
| 4 | S. S. Bracket for Thales Antenna | 1 | |
| 5 | Nylon Bushing, ID.25, 24SW0250 | 12 | |
| 6 | Plastic Reducer Bushing for 1.5"-Pipe 1.9" OD | 1 | |
| 7 | S. S. Washer .275 x .5 x .062 | 8 | |
| 8 | S. S. Button Hd Bolt M6x20 | 8 | Recommended Torque 8 Nm |
| 9 | S. S. Cup Pt Set Screw 3/8 – 16 x 3/8 | 3 | Recommended Torque 30 Nm |

Antenna Pole Mount using M10 Hardware

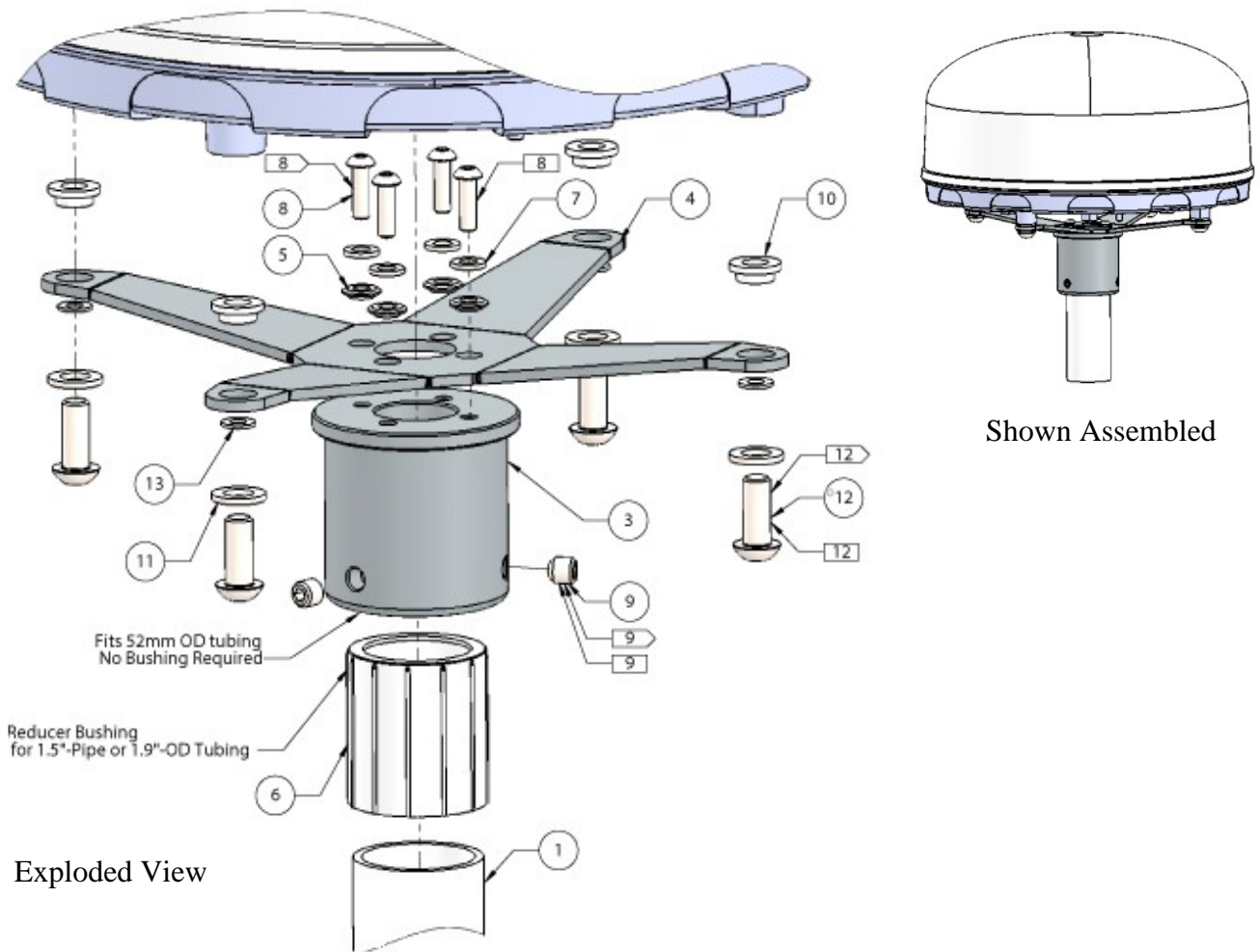

Figure C-3 Thales Antenna Pole Mount Kit – M10 (PN 85739-001)

Table C-2 Antenna Pole Mount using M10 Hardware Kit (PN 85739-001)

| Item Number | Description | Qty | Comment |
|-------------|---|-----|--------------------------|
| 1 | Outside Diameter 1.9" OD | 1 | |
| 2 | Blue Loctite | 1 | Apply to item 8, 9, 12 |
| 3 | S.S. Hub 52mm-ID fo Metric 52mm Tube | 1 | |
| 4 | S. S. Bracket for Thales Antenna | 1 | |
| 5 | Nylon Bushing, ID.25, 24SW0250 | 4 | |
| 6 | Plastic Reducer Bushing for 1.5"-Pipe 1.9" OD | 1 | |
| 7 | S. S. Washer .25" | 4 | |
| 8 | S. S. Button Hd Bolt M6x20 | 4 | Recommended Torque 6 Nm |
| 9 | S. S. Cup Pt Set Screw 3/8 – 16 x 3/8 | 3 | Recommended Torque 30 Nm |
| 10 | Nylon Bushing 10mm | 4 | |
| 11 | S. S. Washer | 4 | |
| 12 | S. S. Button Hd Bolt M10 x 25 | 4 | Recommended Torque 28 Nm |
| 13 | Nylon Washer 10mm | 4 | |



Thales Defense & Security, Inc.
22605 Gateway Center Drive | Clarksburg MD 20871
Toll-Free 1.800.324.6089 | Phone: 240.864.7000 | Fax: 240.864.7920
Email: Customer.Service@thalesdsi.com | Website:
www.thalesdsi.com